



## Beta 1-8 LSCbasic

Part no. 102420, 102422, 102424, 102426, 102428, 102430

## Beta 2-8 LSCbasic

Part no. 102421, 102423, 102425, 102427, 102429, 102431



Freeze-dryer

# Operating Manual

Please retain for later use!



In case of inquiries, please state the following numbers:

Order number:

Serial number:

© Copyright by  
Martin Christ Gefriertrocknungsanlagen GmbH  
An der Unteren Söse 50  
37520 Osterode am Harz  
Germany  
Tel.: +49 (0) 5522 / 5007-0  
Fax: +49 (0) 5522 / 5007-12  
Web: [www.martinchrist.de](http://www.martinchrist.de)  
E-mail: [info@martinchrist.de](mailto:info@martinchrist.de)



---

<b>1</b>	<b>General information</b>	<b>9</b>
1.1	Importance of the operating manual	9
1.2	Intended use	9
1.3	Warranty and liability	11
1.4	Copyright	12
1.5	Explanation of symbols	12
1.6	Standards and regulations	12
1.7	Scope of supply	12
<b>2</b>	<b>Layout and mode of operation</b>	<b>13</b>
2.1	Layout of the freeze-dryer	13
2.1.1	Functional and operating elements	13
2.1.2	Name plate	15
2.2	Mode of operation	16
2.2.1	General information on freeze-drying	16
2.2.2	Freeze-drying process	18
2.2.2.1	Preparation	18
2.2.2.2	Freezing	19
2.2.2.3	Main drying	19
2.2.2.4	Final drying	20
2.2.2.5	End of drying and aeration	20
2.2.2.6	Defrosting	20
<b>3</b>	<b>Safety</b>	<b>21</b>
3.1	Marking of the unit	21
3.2	Explanation of the symbols and notes	22
3.3	Responsibility of the operator	23
3.4	Operating personnel	24
3.5	Informal safety notes	24
3.6	Safety notes concerning the transport, set-up and connection and initial start-up of the freeze-dryer	25
3.6.1	General hazards	25
3.6.2	Hazards caused by improper transport	25
3.6.3	Hazards caused by improper set-up	25
3.6.4	Hazards caused by improper connection	26
3.7	Safety notes concerning the operation	26
3.7.1	Hazards caused by electricity	26
3.7.2	Hazards caused by the refrigeration system (natural, flammable refrigerants)	27
3.7.3	Hazards caused by the refrigeration system (non-flammable refrigerants)	27
3.7.4	Hazards caused by harmful products	28
3.7.5	Hazards caused by solvents in the products	28
3.7.6	Hazards caused by acids in the products	28
3.7.7	Hazards caused by contaminated condensate (defrosting water)	29
3.7.8	Hazards caused by hot surfaces	29
3.7.9	Hazards caused by cold surfaces	29

## Table of contents

3.8	Safety devices .....	29
3.8.1	System check .....	29
3.8.2	Earth conductor check .....	29
3.9	Procedures in the event of hazards and accidents .....	30
3.10	Maintenance and cleaning of the freeze-dryer .....	30
3.11	Measures to be taken to ensure safe operation of the freeze-dryer .....	31
3.12	Remaining hazards .....	32
<b>4</b>	<b>Storage and transport .....</b>	<b>33</b>
4.1	Dimensions and weight .....	33
4.2	Storage conditions .....	33
4.3	Notes on transport .....	34
4.4	Packaging .....	35
4.5	Transport safety devices .....	35
<b>5</b>	<b>Set-up and connection .....</b>	<b>36</b>
5.1	Location of use .....	36
5.2	Power supply .....	37
5.2.1	Type of connection .....	37
5.2.2	Customer-provided fuses .....	37
5.3	Aeration valve .....	37
5.4	Media drain valve .....	38
5.5	Vacuum sensor .....	38
5.6	Vacuum pump .....	40
5.7	Pressure control valve .....	41
5.8	Rubber valves .....	42
<b>6</b>	<b>Operation .....</b>	<b>43</b>
6.1	Initial start-up .....	43
6.2	Installation of accessories .....	43
6.3	Preparation .....	43
6.4	Switching the freeze-dryer on .....	43
6.5	LSCbasic control system .....	44
6.5.1	User interface .....	44
6.5.1.1	Main window "Process" .....	45
6.5.1.2	Main window "Options" .....	53
6.5.1.3	Main window "?" .....	64
6.5.2	Starting a freeze-drying process .....	64
6.5.2.1	Entering set values .....	65
6.6	Optional extensions .....	67
6.7	Switching the freeze-dryer OFF .....	67

**Table of contents**

<b>7</b>	<b>Malfunctions and error correction</b> .....	<b>68</b>
7.1	General malfunctions.....	68
7.1.1	Power failure.....	69
7.1.2	Insufficient vacuum.....	70
7.1.2.1	Small flange connections.....	70
7.1.2.2	Aeration valve, media drain valve.....	71
7.1.2.3	Pressure control valve.....	71
7.1.2.4	Rubber valves.....	71
7.1.2.5	Vacuum sensor.....	71
7.1.3	Insufficient ice condenser temperature.....	72
7.2	Process and error messages.....	72
7.3	Service contact.....	73
<b>8</b>	<b>Maintenance and service</b> .....	<b>74</b>
8.1	Maintenance.....	74
8.1.1	General.....	74
8.1.2	Ice condenser chamber.....	75
8.1.3	Aeration valve, media drain valve.....	76
8.1.4	Heat exchanger (only for air-cooled freeze-dryers).....	77
8.1.5	Electrical system.....	77
8.1.6	Vacuum pump.....	78
8.1.7	Exhaust filter (oil mist separator).....	78
8.1.8	Refrigeration system.....	79
8.1.9	Vacuum sensor.....	79
8.1.10	Accessories.....	80
8.2	Disinfection of the drying chamber and accessories.....	80
8.3	Service.....	81
8.4	Return of defective parts.....	81
<b>9</b>	<b>Disposal</b> .....	<b>83</b>
9.1	Disposal of the freeze-dryer.....	83
9.2	Disposal of the packaging.....	83
<b>10</b>	<b>Technical data</b> .....	<b>84</b>
10.1	Ambient conditions.....	85
10.2	Technical documentation.....	85
<b>11</b>	<b>Appendix</b> .....	<b>86</b>
11.1	Brief operating instructions.....	86
11.2	EC declaration of conformity in accordance with the EC Machinery Directive.....	93
11.3	Declaration of conformity – China RoHS 2.....	95
11.4	EC declaration of conformity in accordance with the Pressure Equipment Directive.....	97
11.5	Table of the sublimation pressure curve.....	99
<b>12</b>	<b>Glossary</b> .....	<b>101</b>
<b>13</b>	<b>Index</b> .....	<b>103</b>

**Table of contents**

---



# 1 General information

## 1.1 Importance of the operating manual

A fundamental requirement for the safe and trouble-free operation of the unit is to be familiar with the fundamental safety instructions and all possible hazards.

The operating manual includes important information concerning the safe operation of the freeze-dryer.

This operating manual, and in particular the notes on safety and hazards, must be observed by all persons operating the unit.

In addition, the local rules and regulations for the prevention of accidents must be complied with.

## 1.2 Intended use

The freeze-dryer has been exclusively designed for the freeze-drying of solid or liquid products in ampoules, vials or dishes. It is, therefore, solely intended for this application.

The freeze-dryer is suitable for freeze-drying solid substances and aqueous solutions (e.g. bacteria and virus cultures, blood plasma, serum fractions, antibodies, sera, vaccines and pharmaceutical products such as chloramphenicol, streptomycin, vitamins, ferments and plant extracts for biochemical tests).

### **Freeze-drying of solvent-containing products (non-aqueous media)**

With regards of corrosion resistance, the use of some organic solvents in aqueous solutions with low concentrations is acceptable.

A freeze-dryer is designed to be chemically resistant to most compounds that are commonly used in freeze-drying processes. However, by necessity, the freeze-dryer is comprised of several different materials, some of which may be attacked and degraded by certain chemicals.

The methods of fabrication and/or conditions of exposure of an acrylic door, as well as the way the chemicals are applied, can influence the results.

Some of these factors are listed below:

- Fabrication: Stress generated while sawing, sanding, machining, drilling, polishing, and/or forming.
- Exposure: Length of exposure, stresses induced during the life of the product due to various loads, changes in temperature etc.
- Application of chemicals: by contact, rubbing, wiping, spraying etc.

## 1 General information

The following table can be used as a general guide for the expected degradation during normal freeze-drying processes of organic solvents with a total max. concentration of 10 vol-% in aqueous solutions.

Solvent	Acrylic glass	Stainless steel	Silicon rubber	EPDM
Acetic acid 20%	+	+	+	o
Formic acid	+	+	o	-
Trifluoroacetic acid (TFA)	-	+	-	+
Calcium chloride	+	o	+	+
Sodium phosphate	+	+	-	+
Acetone	-	+	+	+
Acetonitrile	-	+	+	+
Carbon tetrachloride	-	+	-	-
Cyclohexane	+	+	-	-
Dioxane	+	+	-	o
Methyl-t-butyl ether	+	+	o	-
Pyridine	+	+	-	-
Methanol	-	+	+	+
Ethanol	o	+	+	+
tert-Butanol	-	+	o	o
DMSO	-	+	+	+

Legend: + No degradation to be expected  
o Moderate degradation; limited use  
- Severe degradation; infrequent use recommended; immediate thorough cleaning required

The use of other solvents, e.g. ammonia, should be avoided.

The chemical attack on devices and accessory components can be significantly reduced by immediate cleaning after the end of operation. All parts of the freeze-dryer that have come in contact with the product must be checked regularly for damages and replaced if necessary.

The following features are not permissible or must be deactivated:

- omission of product temperature sensors of the PT100 or LyoRx type or of specially connected PT100 sensors (with a cable connection),



Solvents that are not listed in the table above, or the listed solvents in a concentration higher than 10% by volume, must not be used!

**Freeze-drying of acid-containing products**

Freeze-drying of products containing acids is only permissible if special protective measures and equipment-related precautions are taken. Otherwise, there is a risk of damage to property and personal injury. Consultation of Martin Christ Gefriertrocknungsanlagen GmbH is absolutely mandatory in order to define the measures that need to be taken!

Any other use beyond this area of application is regarded as improper use. Martin Christ Gefriertrocknungsanlagen GmbH cannot be held liable for any damage resulting from such improper use.

The intended use also includes:

- observation of all the notes and instructions included in the operating manual;
- compliance with the inspection and maintenance instruction.

The following operations are regarded as **NOT PERMISSIBLE**:

- operation of the freeze-dryer if it is not properly installed
- use of the freeze-dryer if it is not in a perfect technical state;
- use of the freeze-dryer within hazardous locations where there is a risk of explosions:
- use of the freeze-dryer with unauthorised additions or conversions without the written approval by Martin Christ Gefriertrocknungsanlagen GmbH;
- use of the freeze-dryer with accessories that have not been approved by Martin Christ Gefriertrocknungsanlagen GmbH, with the exception of commercially available freeze-drying vessels made of glass or plastic;
- use of the freeze-dryer with concentrated solvents;
- freeze-drying of products that may react during the freeze-drying process following the supply of high amounts of energy, e.g. solvent-containing products;
- freeze-drying of products containing azides;
- freeze-drying of products that may damage the material of the chamber walls, shelves, pipes, or seals, or that may affect the mechanical strength.

### 1.3 Warranty and liability

The warranty and liability are subject to our "General Terms and Conditions" that were distributed to the operator upon the conclusion of the contract.

Warranty and liability claims are excluded if they are due to one or several of the following reasons:

- improper use
- non-compliance with the safety instructions and hazard warnings in the operating manual
- improper installation, start-up, operation, and maintenance of the freeze-dryer.

## 1 General information

---

### 1.4 Copyright

The copyright concerning the operating manual remains with Martin Christ Gefriertrocknungsanlagen GmbH.

The operating manual is solely intended for the operator and their personnel. It includes instructions and information that may not be

- duplicated,
- distributed, or
- communicated in any other way neither in full nor in parts.

Non-compliance may be prosecuted under criminal law.

### 1.5 Explanation of symbols

In this operating manual, specialist terms that are explained in the glossary (see chapter 12 - "Glossary") are marked by an arrow and printed in italics (e.g. → *sublimation*).

### 1.6 Standards and regulations

EC declaration of conformity in accordance with the EC Machinery Directive (see chapter 11.2 - "EC declaration of conformity in accordance with the EC Machinery Directive")

### 1.7 Scope of supply

**The scope of supply comprises:**

- 1 tube of high-vacuum grease
- 1 litre of vacuum pump oil (only if a pump is included)
- 1 set of flange components and several small parts for service and maintenance purposes
- 1 drain hose 0.5 m (silicone 8 x 12 mm)
- 1 operating manual

#### **Accessories and commissioning**

According to your order, our order confirmation, and our delivery note.

## 2 Layout and mode of operation

### 2.1 Layout of the freeze-dryer

#### 2.1.1 Functional and operating elements

- 1 Ice condenser chamber
- 2 LSCplus user interface (see chapter 6.5.1 - "User interface")
- 3 Mains power switch



*Fig. 1: Total view of the freeze-dryer*

- 4 Pipe connection of the vacuum sensor
- 5 Pipe connection of the vacuum pump (behind the cover plate)
- 6 Ice condenser

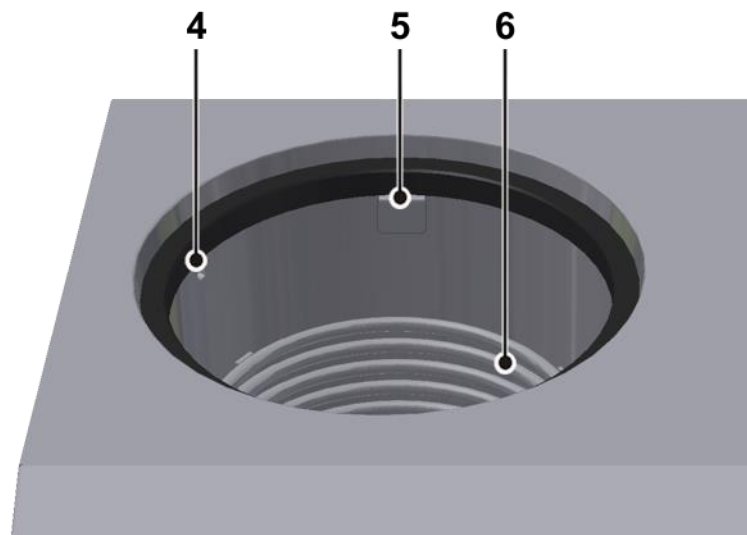

*Fig. 2: Ice condenser chamber*

## 2 Layout and mode of operation

- 7 Aeration valve
- 8 Media drain valve

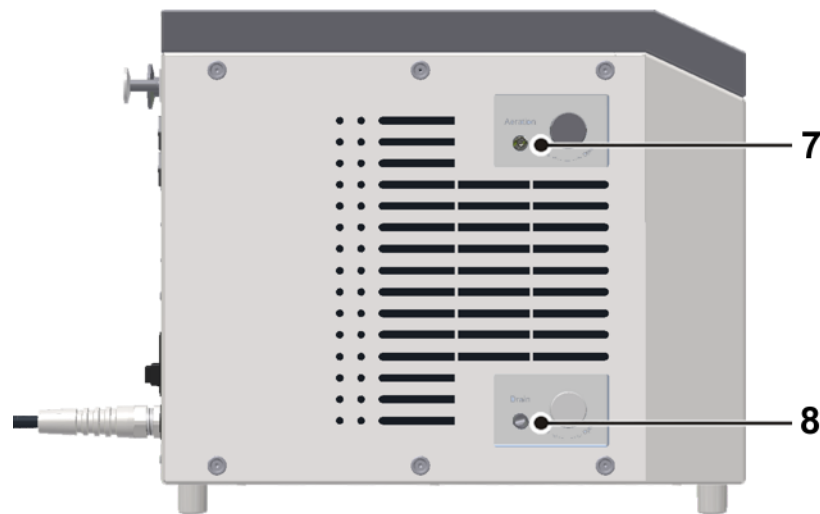

Fig. 3: Left side of the freeze-dryer

- 9 Touchpanel



Fig. 4: User interface with touchpanel

## 2 Layout and mode of operation

- 10 Heat exchanger of the refrigeration unit
- 11 Name plate (see chapter 2.1.2 - "Name plate")
- 12 Vacuum connection
- 13 Serial interface
- 14 Electrical connection of the vacuum sensor
- 15 Connection of the vacuum sensor
- 16 Power supply of the pressure control valve
- 17 Power supply of the vacuum pump
- 18 Mains fuse
- 19 Mains cable
- 20 Equipotential bonding screw

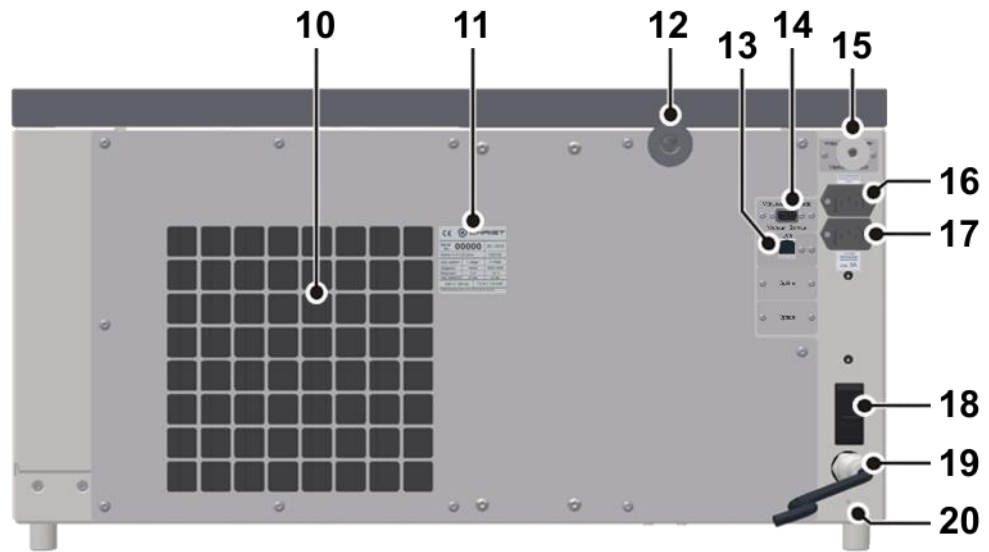

Fig. 5: Rear view of the freeze-dryer

### 2.1.2 Name plate

- 1 Serial number
- 2 Type
- 3 Refrigerant data of the 1<sup>st</sup> stage
- 4 Nominal voltage
- 5 Year of manufacture (month/year)
- 6 Part number
- 7 Refrigerant data of the 2<sup>nd</sup> stage
- 8 Rated current / apparent power

CE			
1	Serial No. <b>00000</b>	03/2018	5
2	Beta 2-8 LSCbasic		6
3	cool. system	1. stage	2. stage
	refrigerant	R404A	R290 / R508
	filling	230g	8g / 76g
	max. pressure	25 bar	25 bar
	max. temp.	120°C	120°C
4	230 V / 50 Hz		6.0 A / 1.3 kVA
D-37520 Osterode am Harz, An der Unteren Söse 50, Germany			

Fig. 6: Example of a name plate

## 2 Layout and mode of operation

---

### 2.2 Mode of operation

#### 2.2.1 General information on freeze-drying

##### What is freeze-drying?

Freeze-drying or lyophilisation is a procedure for the gentle drying of high-quality products. The product is dried by → *sublimation* without passing through the liquid phase.

##### What are typical applications for freeze-drying?

An important area of application is the drying of biotechnological and pharmaceutical products, e.g. tissues and tissue extracts, bacteria, vaccines, and sera. Products that would not keep well when they are dissolved in water can be preserved by freeze-drying. During this process, the biological properties of these sensitive substances are preserved. The compounds remain unchanged from a qualitative and quantitative point of view. After the addition of water, the products will have the same characteristics as the original products.

##### How does freeze-drying work?

Freeze-drying is a very gentle procedure for the extraction of water from a product in the frozen state. The drying process takes place through → *sublimation*, i.e. the direct transition of a product from the solid phase to the gas phase. This happens under vacuum.

The following section describes the process of sublimation based on the example of water, since most products that are processed by freeze-drying are aqueous solutions. Their behaviour is based on identical fundamental principles.

The vapour pressure curve for ice and water (sublimation pressure curve) describes the phase transition as a function of the pressure and temperature. The higher the temperature is, the higher the vapour pressure.

- If the vapour pressure is higher than 6.11 mbar (A), water passes through all three phases: solid, liquid, and gas (see the illustration).
- At 6.11 mbar and 0.0098°C, the melting pressure curve, vapor pressure curve, and sublimation pressure curve meet in one point, the so-called triple point. In this point, all three phases coexist (simultaneously).
- If the vapour pressure is below 6.11 mbar (B) and energy is added, the ice will be directly converted into water vapour once the sublimation curve is reached. This transition is called “sublimation”. If thermal energy is added to pure ice with a temperature of less than –30°C at a pressure of 0.37 mbar, it will be converted into water vapour once it reaches –30°C (see figure).

The vacuum prevents the melting of ice when energy is added. If thermal energy is added to a frozen product under vacuum, thawing of the product will be prevented and the water that is contained within the product will be released in the form of water vapour.



## 2 Layout and mode of operation

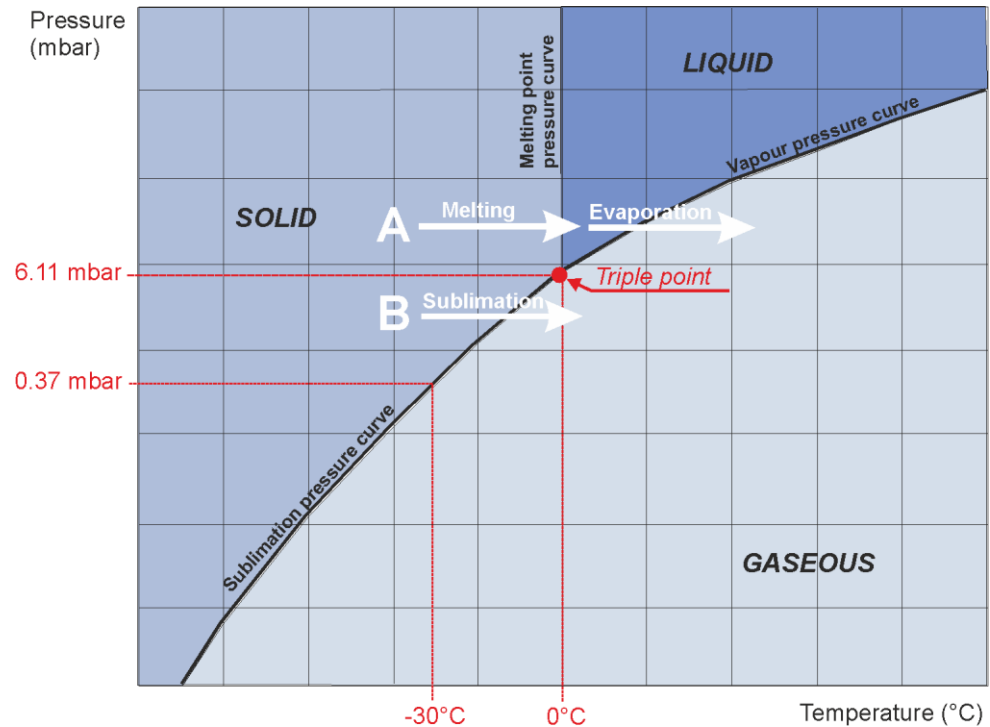

Fig. 7: Vapour pressure curve for ice and water

From a physical point of view, the freeze-drying process covers three phases (see figure below):

(1) Freezing: The product to be dried is frozen under atmospheric pressure. This can be done either directly in the freeze-dryer or in a separate deep-freeze. The freezing temperature should be approximately 10°C below the solidification point of the product.

(2) Evacuation: When the product is sufficiently frozen, the vacuum pump is activated. The pressure inside the drying chamber will be lowered to the value that corresponds to the freezing temperature in accordance with the vapour pressure curve for ice and water.

(3) Sublimation: Thermal energy is added to the product, thus starting the sublimation process. Due to the added energy, the water in the product is converted into water vapour. Since the ice condenser is much colder than the product that is to be dried, the vapour pressure in the ice condenser is considerably lower than above the product. As a result, the water vapour that is released by the product streams to the ice condenser, where it condenses on the condenser coils.

Once the free water has been extracted from the product during the main drying phase, the last traces of bound water will also be removed at a final pressure that is as low as possible and at higher temperatures. This takes place by way of → *desorption*. This drying phase is also called final drying.

## 2 Layout and mode of operation

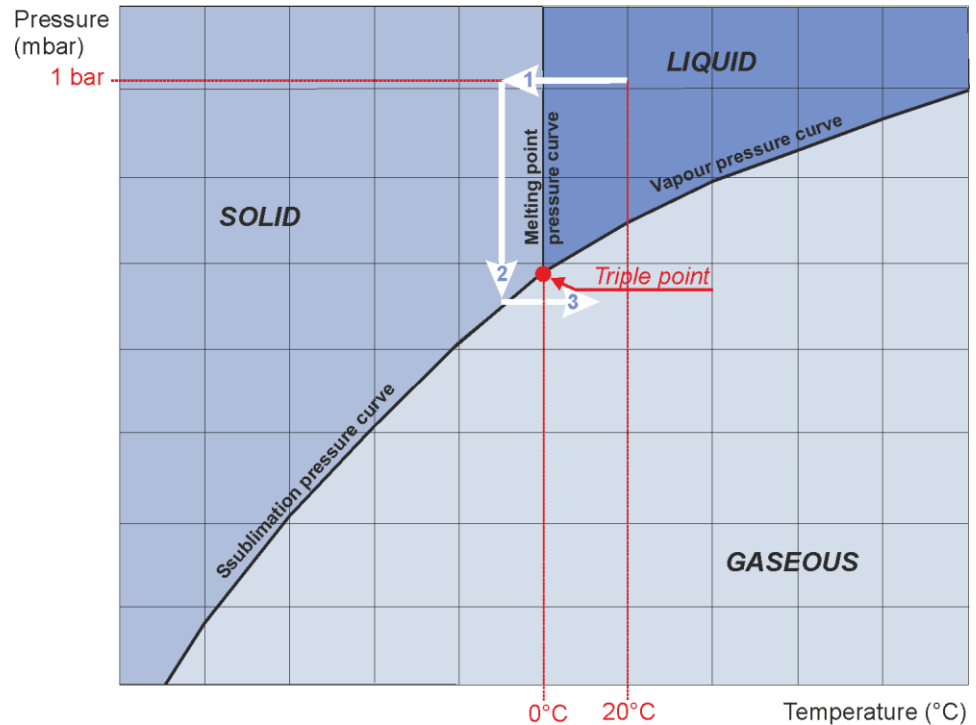

Fig. 8: Freeze-drying phases



Please find further information about basic principles, optimum procedures and applications in the brochure "Smart freeze-drying", which can be downloaded at [www.martinchrist.de](http://www.martinchrist.de) → [Applications] → [Lyophilisation].

### 2.2.2 Freeze-drying process

The main components of a freeze-dryer are:

- vacuum drying chamber or drying manifold,
- vacuum pump for generating a vacuum inside the drying chamber,
- ice condenser for binding the water vapour that is released by the product.

#### 2.2.2.1 Preparation

The ice condenser chamber must be clean and dry. Any water residues from a preceding drying run must be removed.

The media drain valve and the aeration valve must be closed.

In the case of units that are equipped with a pressure control valve (standard on LSCplus and LSCbasic units), the vacuum pump should be warmed up ("warm-up") for at least 15 minutes prior to the start of the main drying phase. Do not subject the vacuum pump to condensable gases until the operating temperature is reached. In this way, the service life of the vacuum pump can be extended.

At the same time, the ice condenser is pre-cooled ("cool-down"). The ice condenser temperature does not have any influence on the product temperature. The sole purpose of the ice condenser is to bind the released water vapour.

**2.2.2.2 Freezing**

First, the product that is to be dried is frozen. Especially in the case of small filling quantities, we recommend pre-cooling the shelves as well in order to prevent the product from thawing during the evacuation.

Two very different structures of the frozen material can be distinguished:

- crystalline structures with clearly distinguishable crystals
- amorphous structures with no crystal junctions at all (e.g. glass)

The majority of the freeze-drying products have a crystalline form.

When freezing these kinds of products, one must take into consideration that too deep and too quick freezing leads to smaller ice crystals, which has a negative effect on the duration of the drying process.

For every product to be dried, the solidification point must be determined as a first step. This is the point at which the water that is contained in the product has completely crystallised. In order to ensure an optimum freeze-drying process, the product temperature should be approximately 10°C below the solidification point.

**2.2.2.3 Main drying**

When the product is frozen, the main drying phase commences. The vacuum pump is switched on. The pressure inside the drying chamber will be lowered to the value that corresponds to the freezing temperature in accordance with the vapour pressure curve for ice and water (sublimation pressure curve). At the same time, thermal energy will be added to the product. In the case of products in round-bottom flasks, wide-neck bottles, etc., this is realised through the environment that is considerably warmer (direct contact heat), in the case of unheated shelves by way of thermal radiation from the environment, and in the case of temperature-controlled shelves directly via the shelves. As a result, the sublimation process starts.

At the beginning of the drying process, the maximum drying rate will be reached. The more the sublimation area recedes into the product, the further the produced water vapour must pass through the layers that have already been dried.

Under certain conditions, it is possible that the vacuum inside the ice condenser chamber increases during the main drying phase (e.g. from 0.63 mbar to 0.47 mbar) although the valve towards the vacuum pump is closed. From a physical point of view, this is due to the pumping effect of the ice condenser ("cryo-pumping effect").

The required drying time depends strongly on the drying vacuum. At 1.0 mbar, one gram of ice takes up a volume of 1 m<sup>3</sup> of vapour, at 0.1 mbar a volume of 10 m<sup>3</sup> of vapour, and at 0.001 mbar a volume of 100 m<sup>3</sup>. The closer the vacuum is to the solidification point, the smaller is the resulting vapour volume. The drying rate increases and the drying time decreases.

## 2 Layout and mode of operation

---

### 2.2.2.4 Final drying

Final drying is an option whenever one requires a product with minimal residual moisture. In the physical sense, this process is a desorption process, i.e. the removal of adsorptively bound water. Final drying is performed under the lowest possible final pressure that depends on the ice condenser temperature in accordance with the vapour pressure curve for ice and water as well as on the final vacuum of the vacuum pump that is used. The process is supported by a higher shelf temperature.

### 2.2.2.5 End of drying and aeration

The end of the drying process is reached when both the product and shelf temperature are clearly in the positive range (+15 to +20°C) and if their difference is not greater than 5 K.

Another indication of the end of the drying process is the behaviour of the vacuum and of the ice condenser temperature. The ice condenser is no longer subject to load and reaches the final temperature of approximately -55°C or -85°C. The pressure in the drying chamber decreases in accordance with the ice condenser temperature.

The vacuum pump will be switched off and the drying chamber will be aerated via a rubber valve or via the aeration valve. The aeration valve can also be used to flood the unit with nitrogen or another inert gas instead of ambient air.

Then, the product can be removed from the unit.

### 2.2.2.6 Defrosting

#### Defrosting with hot gas













As standard, the freeze-dryer is equipped with a hot-gas defrosting system. In order to defrost the ice condenser, heated refrigerant is fed through the heating coil. In addition, the bottom of the ice condenser chamber is heated by way of a heating collar.

In order to avoid damage, the condensate must be drained off through the media drain valve directly after the completion of the defrosting process. Then, any residual water must be removed from the ice condenser chamber by way of a cloth.

### 3 Safety

#### 3.1 Marking of the unit

The following symbols are used for Christ freeze-dryers:

	Dangerous voltage		On (Power)
	Hot surface		Off (Power)
	Caution! Risk of bruising		Name plate (see chapter 2.1.2 - "Name plate")
	Attention, consult the operating manual		Filled with natural inflammable refrigerants
	Protective earth (ground)		CE mark in compliance with the directive 2006/42/EC
	Earth (ground)		China RoHS 2 mark (only for China)
	Unplug the mains plug		

**i**  
NOTE

Safety indications on the freeze-dryer must be kept readable at all times. If necessary, they must be replaced.

**i**  
NOTE

Not all of the symbols/labels are used for this type of freeze-dryer.

### 3 Safety

---

#### 3.2 Explanation of the symbols and notes

This operating manual uses the following names and symbols to indicate hazards:



This symbol stands for a **direct** hazard to the life and health of persons.

Non-observance of these symbols **causes** serious health problems up to life-endangering injuries.



This symbol stands for a **direct** hazard to the life and health of persons due to electrical voltage.

Non-observance of these symbols **causes** serious health problems up to life-endangering injuries.



This symbol stands for a **potential** hazard to the life and health of persons.

Non-observance of these symbols **can** cause serious health problems up to life-endangering injuries.



This symbol indicates a potentially hazardous situation

Non-observance of these notes can cause minor injuries or damage to property.



This symbol indicates important information.

### 3.3 Responsibility of the operator

#### Operating personnel

The operator is obliged to ensure that the persons working on/with the freeze-dryer

- are 18 years old or older,
- have been specifically ordered to do so by the operator/owner and that they have been duly informed about the specific hazards associated with the system, supply media and starting/final products as well as about the correct conduct and necessary measures to take in the event of accidents or malfunctions,
- are familiar with the fundamental health, safety and accident prevention regulations,
- have been trained in terms of the operation of this system,
- have read and understood this operating manual (in particular the safety sections and warning notes) and confirmed this with their signature.

The areas of responsibility of the personnel concerning the operation, maintenance and care of the unit must be clearly defined.

The safety-conscious work of the personnel in compliance with the operating manual and the relevant EC health and safety directives and the national laws concerning health and safety and the prevention of accidents must be checked at regular intervals (e.g. every month).

#### Working area

The operator must

- perform a risk assessment concerning potential accidents in connection with the freeze-dryer and take design-related countermeasures, if necessary.
- perform a compatibility test of all the substances that are used in the freeze-dryer (products to be dried as well as cleaning agents, etc.) and that come into contact with the chamber walls, shelves, pipes/hoses and seals. Substances that damage the material or weaken the mechanical strength must not be used.
- have the system maintained at regular intervals (see chapter 8 - "Maintenance and service").

Any parts or components that are not in perfect working order must be replaced without delay.

#### Additional points concerning the freeze-drying of solvent-containing products

With regards of corrosion resistance, the use of some organic solvents in aqueous solutions with low concentrations is acceptable.

Under certain circumstances, the freeze-drying of products containing solvents may lead to the formation of explosive mixtures. This is why the operator must draw up special operating instructions/SOPs including precise instructions

- concerning the deactivation of specific components, such as PT100 (see chapter 1.2 - "Intended use", section "Freeze-drying of solvent-containing products"),

### 3 Safety

---

- concerning the chamber pressure and shelf temperature for every product that is to be processed in the freeze-dryer,
- concerning the inspection of the freeze-dryer in view of damage caused by the solvent that is used (see chapter 1.2 - "Intended use", section "Freeze-drying of solvent-containing products").

#### 3.4 Operating personnel

It must be ensured that persons operating the unit

- are 18 years old or older,
- have been specifically ordered to operate the unit and made aware of dangers originating from the freeze-dryer, supply media, starting and end products by the operator,
- be familiar with the fundamental regulations concerning workplace safety and accident prevention
- have been trained in terms of the operation of this unit, and
- have read and understood this operating manual (and in particular the safety sections and warning notes) and confirmed this with their signature.

#### 3.5 Informal safety notes

This operating manual is part of the product.

- This operating manual must be kept at the location of use of the freeze-dryer. Ensure that it is accessible at all times.
- The operating manual must be handed over to every subsequent owner or user of the freeze-dryer.
- Any changes, additions or updates received must be added to the operating manual.
- In addition to the operating manual, the general and operational rules and regulations for the prevention of accidents and the protection of the environment must be provided.
- All of the safety and hazards notes on the freeze-dryer must be kept readable at all times. If necessary, they must be replaced.



### 3.6 Safety notes concerning the transport, set-up and connection and initial start-up of the freeze-dryer

The following notes and instructions must be observed in order to protect all persons and property.

#### 3.6.1 General hazards



**WARNING**

##### **General risk of injury**

Among the general hazards during the transport, set-up and connection and start-up of the freeze-dryer are impact hazards, crushing hazards, grazing hazards, cutting hazards, etc.

This may lead to severe injuries.

- Comply with the fundamental health and safety rules and regulations as well as with the rules and regulations for the prevention of accidents!
- Wear personal protective equipment (safety shoes, work gloves, and hardhat)!

#### 3.6.2 Hazards caused by improper transport



**DANGER**

##### **Risk of injury caused by the uncontrolled movement of loads**

Units that are not properly fastened or secured may shift, or fall over.

- Prior to transporting or setting-up the freeze-dryer, read the chapter 4 - "Storage and transport" thoroughly!

#### 3.6.3 Hazards caused by improper set-up



**WARNING**

##### **Risk of injury caused by poor accessibility of the freeze-dryer**

In cramped spaces or locations with poor accessibility, sharp edges and corners may protrude into the work area.

This may lead to injuries caused by impact hazards or grazing hazards.

- Ensure that the freeze-dryer is set up freely accessible!
- Comply with the fundamental health and safety rules and regulations as well as with the rules and regulations for the prevention of accidents!

### 3 Safety

---

#### 3.6.4 Hazards caused by improper connection



**WARNING**

##### **Risk of injury caused by consequences of improper connection**

Improper connection may lead to a hazardous electrical incident at a later time during the operation of the freeze-dryer.

This may lead to severe damage to health or even life-threatening injuries.

- Ensure that the local mains voltage matches the nominal voltage that is stated on the name plate.
- Do not place any dangerous material, e.g. glass vessels containing liquid substances, within the safety area of 30 cm around the freeze-dryer. Spilled liquids may get into the freeze-dryer and damage the electrical or mechanical components.
- Work on the power supply system must only be performed by certified electricians.
- Have the electrical equipment of the unit inspected regularly.
- Defects such as loose or burnt cables must be eliminated immediately.

#### 3.7 Safety notes concerning the operation

The following notes and instructions concerning the operation of the freeze-dryer must be observed in order to protect all persons and property.

##### 3.7.1 Hazards caused by electricity



**DANGER**

##### **Danger of life caused by electric shock**

There is a risk of electric shock when touching current-carrying components.

This may lead to ventricular fibrillation, cardiac arrest, or respiratory paralysis.

- Only qualified electricians are authorised to perform work on the electrical system of the freeze-dryer!
- The electrical equipment of the freeze-dryer must be checked at regular intervals by a qualified electrician!
- Defects such as loose connections or burnt cables must be eliminated immediately.

**3.7.2 Hazards caused by the refrigeration system (natural, flammable refrigerants)****DANGER****Risk of explosion due to refrigerants**

The refrigerants used are highly flammable and can form an explosive mixture if their concentration in the ambient air is sufficiently high.

There is an explosion hazard.

- Work on the refrigeration system of the freeze-dryer must only be carried out by qualified specialist personnel who have been trained to handle flammable refrigerants!
- Ensure good ventilation and make sure that no ignition sources (e.g. soldering iron, welding equipment) are present!

**3.7.3 Hazards caused by the refrigeration system (non-flammable refrigerants)****WARNING****Risk of poisoning caused by the refrigerant**

During its decomposition (e.g. due to naked flames or hot surfaces), hazardous/toxic gases are released.

Contact with the decomposition products may cause severe damage to health.

- Only qualified persons are authorised to perform work on the refrigeration system of the freeze-dryer!
- Do not eat, drink, or smoke when working on the refrigeration system!

**WARNING****Risk of cold burns or frostbite caused by the refrigerant**

When work is performed on the refrigeration system of the freeze-dryer, refrigerant may escape in the liquid or gas state and under high pressure.

In the case of skin contact with liquid refrigerant, cold burns or frostbite may result.

- Only qualified persons are authorised to perform work on the refrigeration system of the freeze-dryer!

### 3 Safety

#### 3.7.4 Hazards caused by harmful products



**DANGER**

##### **Risk of poisoning/infection caused by the products**

When loading and unloading the drying chamber, the personnel are exposed to the product.

Skin contact or the inhalation of particles may cause severe damage to health depending on the product in question.

- Wear suitable protective clothes, gloves, and respiratory protection!



**DANGER**

##### **Risk of poisoning/infection caused by the products**

When performing maintenance work on parts coming into contact with the product (e.g. all parts inside the chamber), the personnel may be exposed to product residues.

Skin contact or the inhalation of particles may cause severe damage to health depending on the product in question.

- Take suitable decontamination measures prior to commencing the maintenance!
- Wear suitable protective clothes, gloves, and respiratory protection!

#### 3.7.5 Hazards caused by solvents in the products



**DANGER**

##### **Explosion hazard caused by solvents in the products**

When freeze-drying products containing solvents, gas mixtures may form. These gas mixtures may be ignited on certain components of the freeze-dryer.

There is an explosion hazard.

- Solvents that are not included in the table in chapter 1.2 - "Intended use", or the listed solvents in a concentration higher than 10% by volume, must not be used!
- Refer to the safety data sheets of the products that are used!

#### 3.7.6 Hazards caused by acids in the products



**DANGER**

##### **Risk of injury caused by acids in the products**

Products containing acids may damage the material of the components of the freeze-dryer and affect the mechanical strength.

This may lead to severe injuries.

Freeze-drying of products containing acids is only permissible if special protective measures and equipment-related precautions are taken!

Consultation of Martin Christ Gefriertrocknungsanlagen GmbH is absolutely mandatory in order to define the measures that need to be taken!

- Refer to the safety data sheets of the products that are used!

### 3.7.7 Hazards caused by contaminated condensate (defrosting water)



**WARNING**

#### **Risk of poisoning/infection caused by contaminated condensate (defrosting water)**

The condensate may contain harmful substances originating from the product.

Contact with the condensate may cause severe damage to health.

- Ensure the environmentally sound disposal of the condensate in compliance with the local rules and regulations!
- Wear suitable protective clothes, gloves, and respiratory protection when performing any work on the drain system (especially when cleaning the valves and replacing the seals)!

### 3.7.8 Hazards caused by hot surfaces



**WARNING**

#### **Risk of burns on hot surfaces**

After a drying process, the surfaces inside the chamber may still be hot. There is a risk of burns when touching the surfaces.

- Wear suitable protective clothes and gloves!
- Do not touch the surfaces on purpose!

### 3.7.9 Hazards caused by cold surfaces



**WARNING**

#### **Risk of freezing to cold surfaces**

The ice condenser coils can already be cold during the loading phase. There is a risk of freezing to the ice condenser coils when touching the surfaces.

- Wear suitable protective clothes and gloves!
- Do not touch the surfaces on purpose!

## 3.8 Safety devices

### 3.8.1 System check

An internal system check system monitors the data transfer and sensor signals with regard to plausibility. Errors are detected by continuous self-monitoring of the system. Error messages are displayed in the main window under "Process & equipment messages" (chapter 6.5.1.1 - "Main window "Process"", chapter 7.2 - "Process and error messages").

### 3.8.2 Earth conductor check

For the earth conductor check, there is an equipotential bonding screw on the rear panel of the freeze-dryer. An earth conductor check can be carried out with the aid of a suitable measuring instrument.

### 3 Safety

---

## 3.9 Procedures in the event of hazards and accidents

### Hazardous electrical incident:

- Set the control switch to the "0" position in order to interrupt the power supply completely.

### Fire:

- A fire in the electrical control system must be extinguished with a CO<sub>2</sub> fire extinguisher!
- Burning oil must be extinguished with a CO<sub>2</sub> fire extinguisher or powder fire extinguisher!

### Electric shock:

- While ensuring your **own safety**, interrupt the circuit as quickly as possible (control switch). Keep the affected persons warm and calm. **Get medical attention immediately!** Check consciousness and breathing continuously. In the case of unconsciousness or lack of normal breathing, perform cardiopulmonary resuscitation (CPR).

### Burns:

- Cool small-area burns (e.g. finger) immediately with cold water for approximately 2 minutes.
- Do not cool if larger areas of the body surface are burnt since there is a risk of hypothermia.
- Cover the burns loosely and in a sterile manner (e.g. with sterile dressing).
- Keep the affected persons warm and calm.

**IF IN DOUBT, CALL THE EMERGENCY PHYSICIAN (AMBULANCE)!**

## 3.10 Maintenance and cleaning of the freeze-dryer

The substances and materials that are used must be properly handled and disposed of (Please refer to the safety data sheets!). This applies particularly to

- the handling of solvents, lyes, and acids,
- the changing and topping-up of operating supplies.

Compliance with the national rules and regulations must be ensured.

### **3.11 Measures to be taken to ensure safe operation of the freeze-dryer**

In order to ensure the safe operation of the freeze-dryer, please comply with the following points prior to every freeze-drying process:

#### **Set-up, connection and operation**

- Ensure that the freeze-dryer was set up and connected properly (see chapter 5 - "Set-up and connection").
- Check the freeze-dryer and the accessories before every start-up for any visible signs of damage.
- Do not hit or move the freeze-dryer during its operation.
- Do not lean against or rest on the freeze-dryer during its operation.
- Stop the freeze-dryer immediately in the event of a malfunction. Eliminate the malfunction (see chapter 7 - "Malfunctions and error correction") or contact the after-sales service of Firma Martin Christ Gefriertrocknungsanlagen GmbH (see chapter 7.3 - "Service contact").
- Ensure that all repairs are performed only by authorised and specialised personnel.

#### **Fire prevention**

- Fuses protect certain electrical circuits within the freeze-dryer against over-current conditions. Always use fuses of the same type and rating.

#### **Safety area**

- Maintain a safety distance of at least 30 cm (12 inches) around the freeze-dryer.
- Do not store any dangerous goods in the safety area of the freeze-dryer.
- Do not place any dangerous material, e.g. glass vessels containing liquid substances, within the safety area of 30 cm around the freeze-dryer. Spilled liquids may get into the freeze-dryer and damage the electrical or mechanical components.
- Do not stay in the safety area longer than what is absolutely necessary for the operation of the freeze-dryer.

#### **Accessories**

- Do not use the freeze-dryer with accessories that shows signs of damage.
- Only use accessories that have been approved by the manufacturer (except for commercial vessels made of glass or synthetic materials). We explicitly warn against the use of equipment of poor quality! Breaking glass or bursting vessels can cause dangerous situations.

### 3 Safety

---

#### Handling hazardous materials

- The generally applicable regulations for handling flammable substances in laboratories / workplaces must be observed.
- During sample preparation, loading and unloading of samples and defrosting, appropriate safety precautions must be observed.
- Depending on the used solvent, hot gas defrosting should be avoided.
- Caution when handling hazardous materials such as strong acids or bases, radioactive substances and volatile organics: If such substances are spilled, they must be cleaned up immediately.
- If a sample with hazardous materials such as strong acids or bases, radioactive substances or volatile organics is spilled inside a chamber, they must be cleaned up immediately.
- Caution when handling solvents: Keep sources of ignition away from solvents.
- When using flammable or hazardous solvents, the vacuum pump must be vented to or operate inside a fume hood.

#### 3.12 Remaining hazards

All Christ freeze-dryers were built state-of-the-art and according to the accepted safety rules. Danger to life and limb of the operator, or of third parties, or impairments of the units or other material assets, however, cannot be completely excluded when the units are being used.

Use the freeze-dryer

- only for the purpose that it was originally intended for (see chapter 1.2 - "Intended use") and
- only if it is in a perfect running state.
- Immediately eliminate any problems that can affect safety.



## 4 Storage and transport

### 4.1 Dimensions and weight

Values for the freeze-dryer without a vacuum pump:

	Beta 1-8 LSCbasic	Beta 2-8 LSCbasic
Height:	415 mm	415 mm
Width:	780 mm	780 mm
Depth:	555 mm + 80 mm vacuum connection	555 mm + 80 mm vacuum connection
Weight:	approx. 63 kg	approx. 78 kg

### 4.2 Storage conditions

In order to ensure the protection against mechanical and climatic influences, the guidelines of the German Federal Association for Wooden Packages, Pallets, and Export Packaging (Bundesverband Holzpackmittel, Paletten, Exportverpackung e.V.), the so-called HPE packaging guidelines, must be applied when packing and storing the freeze-dryer.

The storage must be:

- dust-free
- dry
- free from excessive temperature fluctuations
- free from a mechanical load.

## 4 Storage and transport

### 4.3 Notes on transport

- Use suitable packaging for the transport, and if at all possible, the original packaging.
- Install all transport safety devices (see chapter 4.5 - "Transport safety devices").
- Over short distances, the freeze-dryer can be transported by a suitable number of persons who reach under it from the sides.
- When lifting the freeze dryer, always reach under the freeze-dryer from the side. Do not grab the unit at the plastic control panel (see figures below).

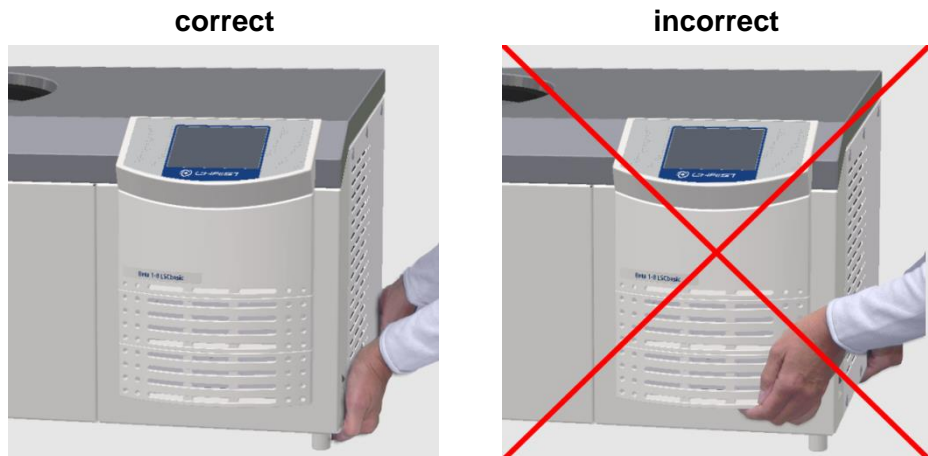

Fig. 9: Lifting the freeze-dryer



**CAUTION**

The freeze-dryer Beta 1-8 LSCbasic weighs approx. 63 kg!  
The freeze-dryer Beta 2-8 LSCbasic weighs approx. 78 kg!



**CAUTION**

The centre of gravity of the freeze-dryer is off-centre!

- When setting the unit down, ensure that the feet are upright (see figures below).



Fig. 10: Unit feet

## 4.4 Packaging

The freeze-dryer is packaged in a wooden crate.

- After opening the packaging, take out the accessories.
- Remove the packaging material.
- Remove the side walls of the crate.
- Lift the freeze-dryer upwards and out of the crate/cardboard box. When lifting the unit, always reach under the freeze-dryer from the side.



### CAUTION

The freeze-dryer Beta 1-8 LSCbasic weighs approx. 63 kg!  
The freeze-dryer Beta 2-8 LSCbasic weighs approx. 78 kg!



### CAUTION

The centre of gravity of the freeze-dryer is off-centre!

- Retain the packaging for any possible future transport of the freeze-dryer.

## 4.5 Transport safety devices

Prior to start-up, the vacuum sensor must be installed (see chapter 5.5 - "Vacuum sensor").



### NOTE

Prior to any transport, the transport safety devices must be deinstalled.

## 5 Set-up and connection

### 5.1 Location of use

Use the freeze-dryer solely in closed and dry spaces.



Refrigeration problems of the freeze-dryer are often caused by insufficient conditions at the location of use. This is why compliance with the following conditions is absolutely mandatory!

- The table must be stable and have a solid, even tabletop
- Ensure sufficient ventilation. Do not place any paper, cloth or similar material behind or under the unit, since otherwise the air circulation will be impaired.
- Keep a safety distance of at least 30 cm around the freeze-dryer so that the vents in the unit remain fully effective.
- The ambient temperature must be in the range of +5°C to +25°C. A potential night-time setback of the air conditioning system must be taken into consideration.
- Prevent the room temperature from rising, for example due to closed doors at night.
- Do not subject the freeze-dryer to thermal stress, e.g. by positioning it near heat generators.
- Prevent thermal overload, e.g. caused by other equipment in the direct vicinity of the freeze-dryer.
- Do not set up the vacuum pump in the area of the heat exchanger ventilation grid (see chapter 2.1.1 - "Functional and operating elements").
- In the case of water-cooled systems, ensure that the water circuit provides a sufficient amount of cooling water.
- Avoid direct sunlight (UV radiation).

## 5.2 Power supply

### 5.2.1 Type of connection



**DANGER**

#### **Danger of life caused by electric shock**

There is a risk of electric shock when touching current-carrying components.

This may lead to ventricular fibrillation, cardiac arrest, or respiratory paralysis.

- Only qualified electricians are authorised to perform work on the electrical system of the freeze-dryer!
- The electrical equipment of the freeze-dryer must be checked at regular intervals by a qualified electrician!
- Defects such as loose connections or burnt cables must be eliminated immediately.



**DANGER**

The operating voltage on the name plate must correspond to the local supply voltage!

Christ freeze-dryers are units of protection class I. Freeze-dryers of this type have a three-wire power cord with an IEC C13 connector (see chapter 10 - "Technical data").

An equipotential bonding screw is located on the back (see chapter 2.1.1 - "Functional and operating elements"). This equipotential bonding screw can be used to perform an earth conductor check.

### 5.2.2 Customer-provided fuses

Typically, the freeze-dryer must be protected with 16 A fuses that are to be provided by the customer.

## 5.3 Aeration valve

The aeration valve is located on top of the left side of the unit (see chapter 2.1.1 - "Functional and operating elements").

After the end of a freeze-drying process, the unit will be aerated via the aeration valve.



The ice condenser chamber can be flooded with nitrogen via the hose nozzle of the aeration valve.

## 5 Set-up and connection

### 5.4 Media drain valve



**WARNING**

#### **Risk of poisoning/infection caused by contaminated condensate (defrosting water)**

The condensate may contain harmful substances originating from the product.

Contact with the condensate may cause severe damage to health.

- Ensure the environmentally sound disposal of the condensate in compliance with the local rules and regulations!

The media drain valve is located at the bottom of the left side of the unit (see chapter 2.1.1 - "Functional and operating elements").

It is used to drain off the condensate and the defrosting water.

- Connect the drain hose (included in the scope of supply) to the hose connector.
- Place a collecting vessel under the unit.

The hose must be laid with a continuous slope and the end of the hose must always be above the liquid level in the collecting vessel. This prevents water and dirt residues from being sucked into the ice condenser chamber if there is negative pressure when the media drain valve is opened.

### 5.5 Vacuum sensor



**NOTE**

Please refer to the separate operating manual of the vacuum sensor!

In order to protect the vacuum sensor against transport damage, it comes supplied in its original packaging. Prior to commissioning the freeze-dryer, the sensor must be installed.

- 1 Vacuum sensor
- 2 Connection socket



Fig. 11: Position of the vacuum sensor and the connection socket

## 5 Set-up and connection

- Switch the unit off by actuating the mains power switch.
- Take the vacuum sensor out of its original packaging and fasten it to the connector with a bow-shaped connecting piece, two clamping rings (DIN16KF) and two centring rings (included in the scope of supply).
- Plug the connector to the connection socket and hand-tighten the screws on the connector.



**NOTE**

It is absolutely essential to comply with the manufacturer's instructions in the separate operating manual of the vacuum sensor!

Thyracont VCP63 (Pirani)



Pfeiffer CMR 363 (capacitive)



Fig. 12: Vacuum sensors of different manufacturers



**NOTE**

The vacuum sensor comes supplied in a calibrated state.

After the freeze-dryer has been switched on, the vacuum sensor needs several minutes until it is ready for operation.

## 5 Set-up and connection

### 5.6 Vacuum pump



It is absolutely essential to refer to the separate instruction manual of the vacuum pump and exhaust filter (if applicable)!

The vacuum pump must be connected to the vacuum connection of the unit and to the electrical socket at the back of the unit, which is marked accordingly (see chapter 2.1.1 - "Functional and operating elements").



The vacuum pump is supplied with power by the unit, but the maximum current for the vacuum pump is limited. It is absolutely essential to refer to the label of the electrical outlet for the vacuum pump (see the following picture)!

If the current requirement of the vacuum pump is higher than the value that is stated on the label, the pump must be supplied separately via an on-site power socket.

- 1 Label indicating the maximum current

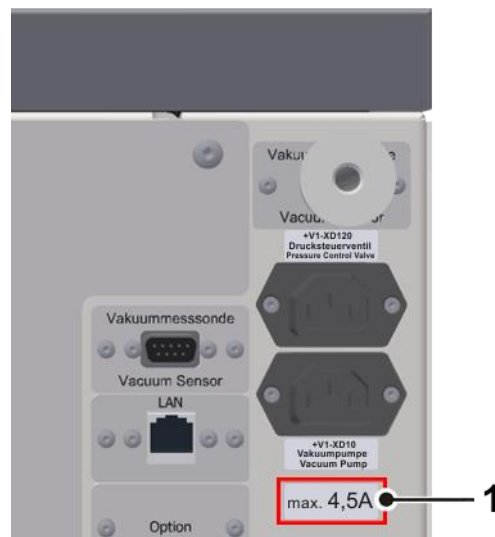

Fig. 13: Indication of the maximum current for the vacuum pump (example)

The oil mist that escapes from the pump during operation must be retained or discharged via an exhaust filter (oil mist separator).

- We strongly recommend using an oil mist separator. The filter prevents air pollution by the oil mist that is emitted more or less strongly by the pump depending on the working pressure.
- The exhaust gases must be discharged in a proper manner.
- The hose line must be laid in such a manner that any condensation water cannot flow back into the pump. In the case of a rising hose line, we recommend using a condensate trap (Woulff bottle or wash bottle).



## 5.7 Pressure control valve

The pressure control valve is integrated in the suction pipe between the vacuum pump and ice condenser chamber. During certain, specified process phases, it interrupts the volume flow to the vacuum pump (see chapter 2.2.1 - "General information on freeze-drying")



**CAUTION**

Observe the installation direction of the pressure control valve (see figure)!

- 1 Connection to the vacuum pump
- 2 Pressure control valve

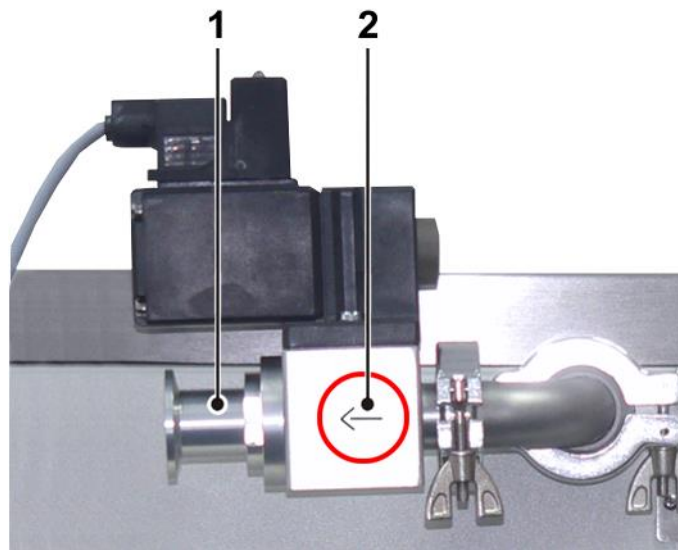

*Fig. 14: Installation of the pressure control valve*

## 5 Set-up and connection

### 5.8 Rubber valves

The rubber valves (part no. 121860) enable the connection of round-bottom flasks, wide-neck filter bottles, or distributors for ampoules to a manifold or drying chamber. Depending on the connector of the components, the blue plug can be removed.

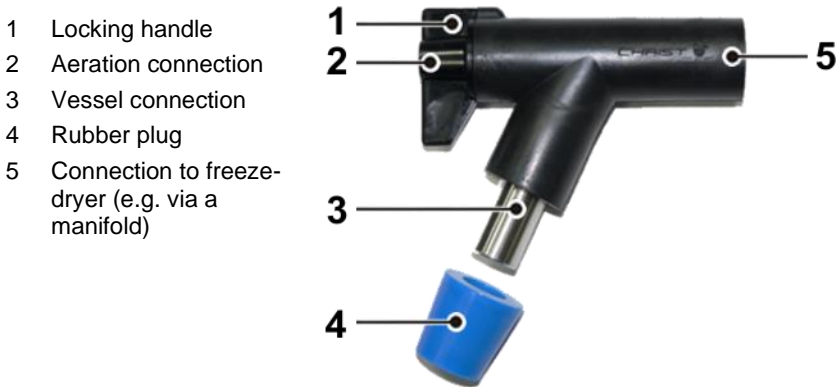

Fig. 15: Rubber valve



The rubber valves come supplied in an ungreased state. This is why a thin layer of vacuum grease must be applied to the connector of the freeze-dryer as well as to the vessel connector prior to start-up in order to ensure trouble-free operation.

In position A (see figure below), the aeration connector is open and the vessel connector is closed. The accessory will be aerated while the vacuum inside the drying chamber is maintained. As a result, vessels can be exchanged without any interruption of the drying process.

In position B, the aeration connector is closed and the vessel connector is open. The connected accessory is connected to the freeze-dryer.

In position C, the aeration connector and the vessel connector are closed.

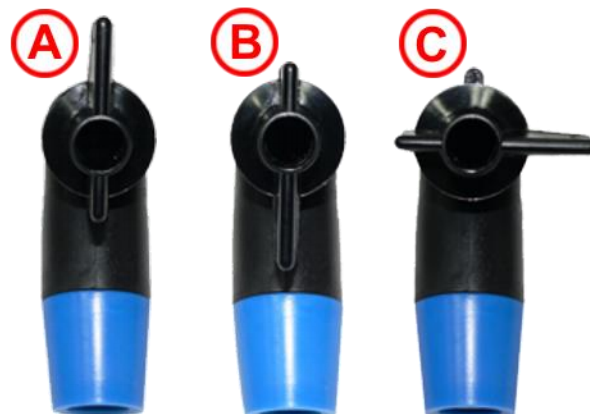

Fig. 16: Possible positions of the locking handle

## 6 Operation

### 6.1 Initial start-up



**WARNING**

Before the initial start-up, please ensure that your freeze-dryer is properly set up and installed (see chapter 5 - "Set-up and connection")

### 6.2 Installation of accessories

The accessories must be completed in accordance with the drying method that is applied as well as in accordance with the scope of supply.

### 6.3 Preparation

The ice condenser chamber must be clean and dry.

- Remove any water residues from the preceding run.
- Close the aeration valve and the media drain valve.
- Ensure that all of the valves of the accessories are closed.
- Switch the vacuum pump on.

### 6.4 Switching the freeze-dryer on

- Actuate the mains switch.

The control unit performs a self-test and an initialisation. This may take several seconds.

- Follow the safety instructions and hazard warnings (see chapter 3 - "Safety")!

## 6 Operation

### 6.5 LSCbasic control system

The control system LSCbasic (Lyo Screen Control basic) was specifically developed for the control of freeze-drying processes. The clear user interface enables the intuitive operation of the unit.



Fig. 17: Start screen of the LSCbasic control unit (example)

#### 6.5.1 User interface

The system is operated via a touch panel, i.e. by touching the buttons on the display. Every button is marked by a frame. Pressing the button activates the associated function. Depending on the function, a dialogue box opens, a value can be changed, or a transaction can be confirmed.

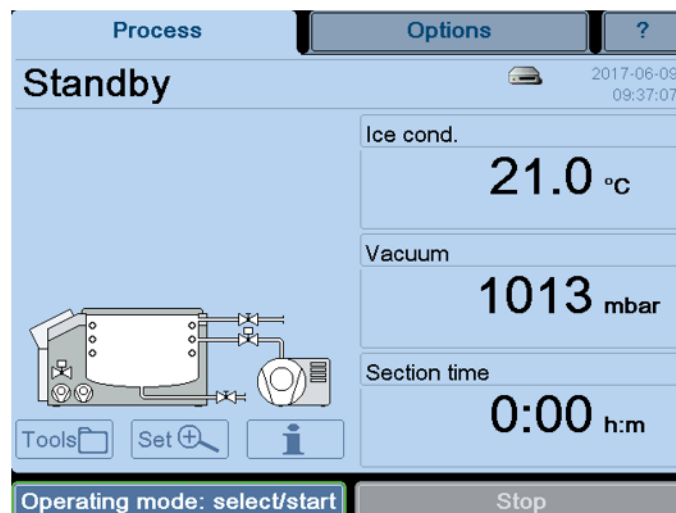

Fig. 18: User interface LSCbasic

The user interface is divided into three main windows that can be called up by touching the corresponding buttons:

**Process**

This window is also the standard user interface. It is used to control the freeze-drying process manually.

**Options**

This window is used for personalised settings that enable the users to adapt the system as far as possible to their respective area of activity.

?

In this window, the users can find all of the relevant information concerning the control system at a glance. In the event of enquiries at the factory, these data facilitate the assignment and expediting of the processing of the enquiries.

**6.5.1.1 Main window "Process"**

This main window shows all of the relevant process data. Here, the individual phases of a freeze-drying process can be controlled manually.

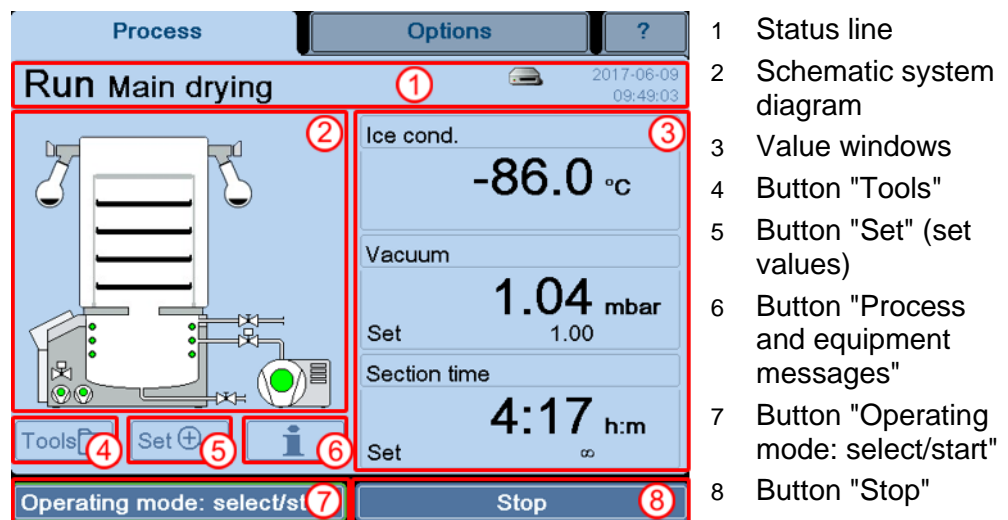

Fig. 19: Overview of the main window "Process"





**Status line (1)**

This line shows the operating status of the freeze-dryer as well as the active phase.

The status line also shows the current date and time. The clock is battery-buffered and must be reset after a failure (chapter 6.5.1.2 - "Main window "Options"", section "Administration").

In addition, the drive symbol provides information concerning the status of the external data storage device or of the network drive. The following symbols are possible:

## 6 Operation

No symbol	No USB storage device or LAN network connected
	USB storage device connected
	Active process recording on a USB storage device
	Network available, but no network drive connected
	Network drive connected (e.g. LyoLogplus)
	Network drive connected and active process recording

### Button "Schematic system diagram" (2)

The left side of the user interface shows a schematic view of the system including all of its components. Active components are displayed in green. Touching a component calls up its name and → *reference designation*.

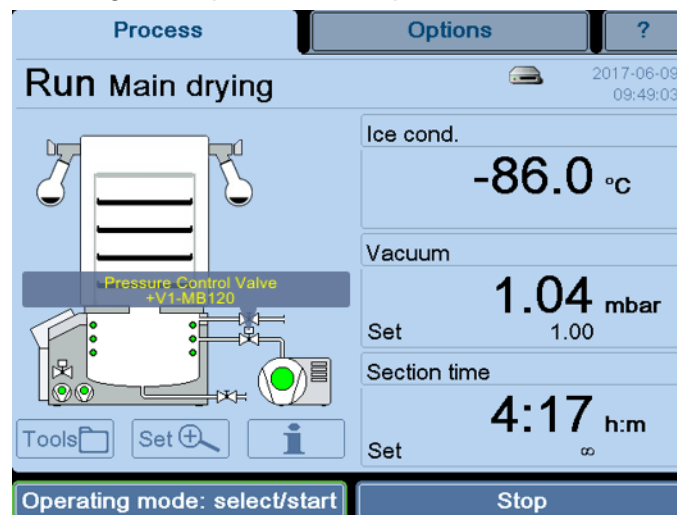

Fig. 20: Schematic system diagram with the name and reference designation of the component

### Value windows (3)

This area shows the current process data. The three value windows can be configured as desired.

- Select the button of the value window that is to be adapted. A dialogue box with the possible parameters opens:
  - Total time (duration of the entire freeze-drying process up to this moment)
  - Section time (duration of the current section up to this moment)
  - Ice condenser (temperature of the ice condenser)
  - Vacuum (value of the vacuum inside the ice condenser chamber)
  - Temperature  $\triangleq$  vacuum (conversion of a vacuum value into a temperature value based on the vapour pressure curve for ice and water)

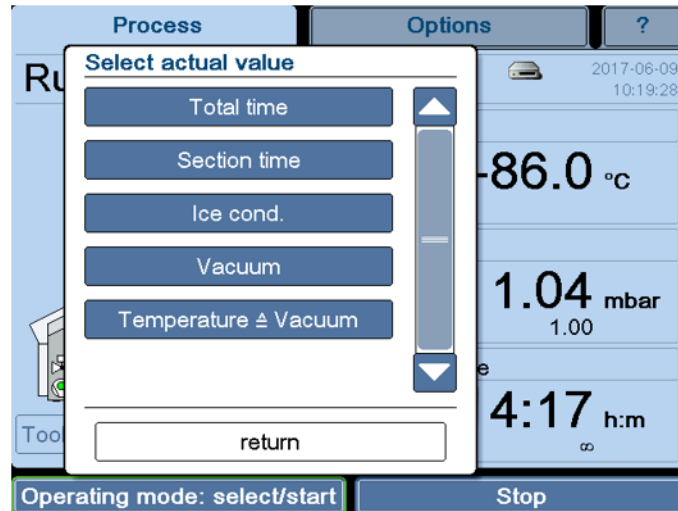

Fig. 21: Dialogue box "Select actual value"

- Select the desired configuration or exit the dialog box by pressing the "return" button.

In this way, it is possible to configure a personalised overview of the actual values.

#### Dialogue box "Tools" (4)

This dialog box is used to call up various aids and resources.

#### Vapour pressure curve for ice and water

A diagram shows the relationship between the pressure and sample temperature. The pressure and temperature values can be changed by way of the buttons or by moving the arrows (see item 1 in the screenshot). The other value will be adapted automatically.

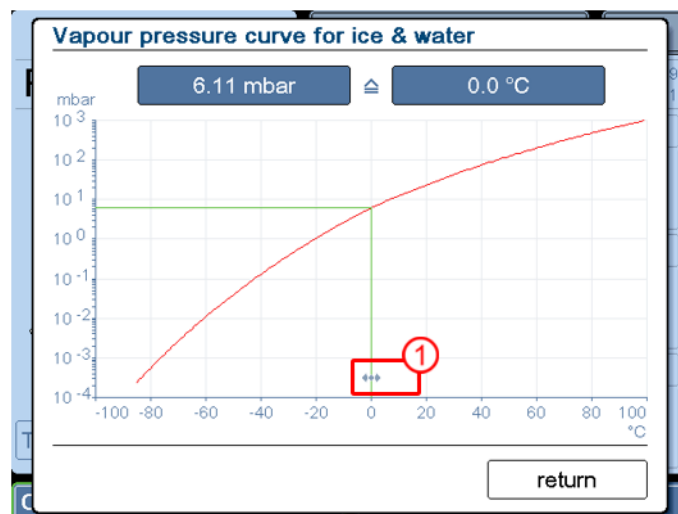

Fig. 22: Dialogue box "Vapour pressure curve for ice and water"

## 6 Operation

### Option: USB process recording

(see chapter 6.6 - "Optional extensions")

- Select the "USB process recording" function in the dialogue box "Tools".
- Select the input fields ("Batch data"). A keyboard for the data input will be displayed.
- If necessary, select the "Options" tab, choose between manual or automatic recording, and define a recording interval.
- Press the "return" button in order to close the dialogue box.

The process recording will now run in the background.

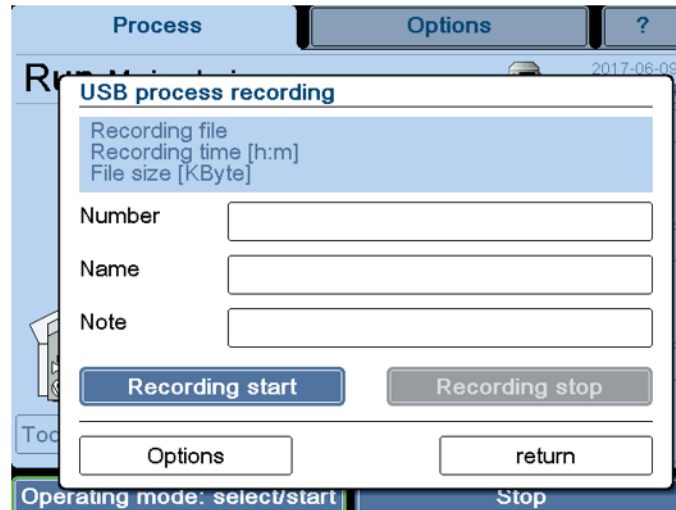

Fig. 23: Dialogue box "USB process recording"

### Option: Lifting hoist<sup>1</sup>

(see chapter 6.6 - "Optional extensions")

This function is described in the separate operating manual of the lifting hoist.

### **Button "Set" (5)**

This button is used to enter the set values for the individual phases of the freeze-drying process prior to the start of the process. Value ranges have been saved for the various phases. These value ranges can be displayed in the input window with the aid of the buttons "min" or "max" (see chapter 6.5.2.1 - "Entering set values").

### **Dialogue box "Process and equipment messages" (6)**

This dialogue box is used to view and save all of the error messages and other messages. In the event of an error or message, the window "Process and equipment messages" will open automatically. In addition, a sound signal is emitted until the error is acknowledged.

<sup>1</sup> Not available for Alpha 3-4 LSCbasic



There are three categories of faults:

- Red: error messages
- Orange: process messages
- Yellow: general messages

The representation of the message provides information about its current status. A double frame around a message means that the error has not been eliminated yet. The colour of the button "quit" changes from blue to grey once the message has been acknowledged.

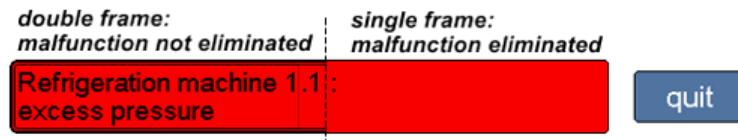

Fig. 24: Representation of an error message

The advantage of this system is that faults that occurred during the night can be discovered the next day even if the cause of the fault has already been eliminated.

The dialogue box cannot be quit until all of the messages have been acknowledged.

If a message has been acknowledged even though the fault has not been eliminated, the button "Process and equipment messages" will be displayed in the respective colour of the fault in the main window.

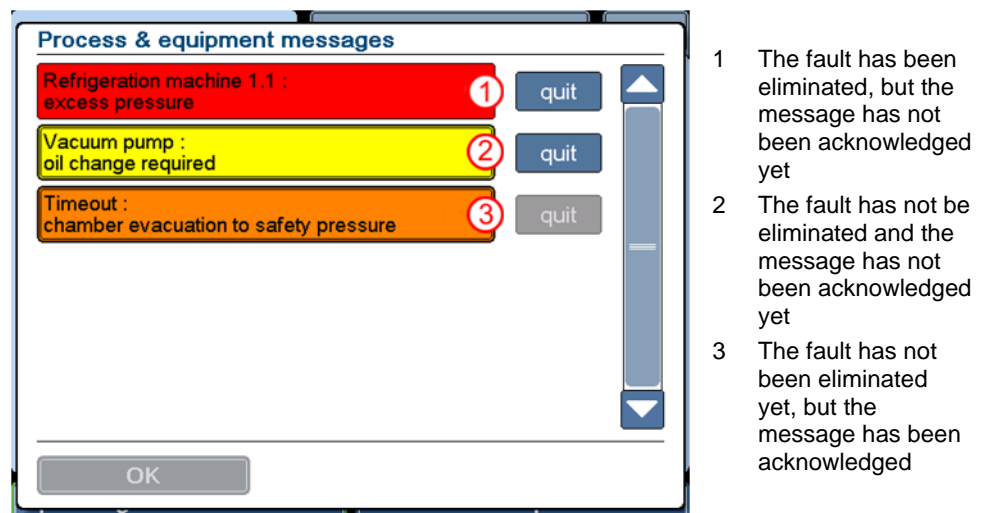

Fig. 25: Dialogue box "Process and equipment messages"

Details

Tapping the message displays details concerning the error message:

- Cause of the message
- Effects of the message
- Measures to eliminate the error
- → *Reference designation*
- Error counter (indicates how often this error has occurred) and the time stamp of the last error message.

## 6 Operation

Use the arrow buttons to open the individual windows.



The error message text is always followed by an error code. Always indicate the error code in the event of enquiries or service requests!

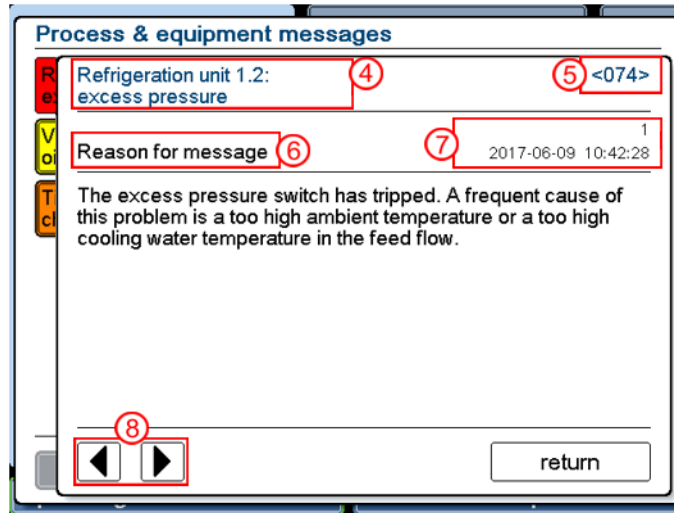

- 4 Error message
- 5 Error code
- 6 Detailed information
- 7 Error counter and time stamp of the last error
- 8 Arrow buttons

Fig. 26: Details concerning an error message



The texts of the process and error messages are not included in this operating manual.

The associated documents can be requested from our service department.

### Dialogue box "Operating mode: select/start" (7)

After the set values have been entered for the process, the process can be started with this function (see chapter 6.5.2 - "Starting a freeze-drying process").

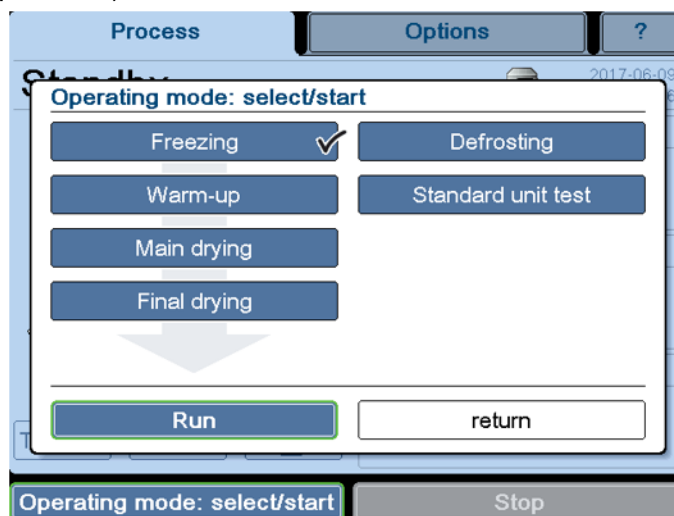

Fig. 27: Dialogue box "Operating mode: select/start"

(The version of the dialogue box that is displayed depends on the equipment of the freeze-dryer.)

### Button "Standard unit test"

Apart from the process phases of the freeze-drying process ("Freezing", "Warm-up", "Main drying" and "Final drying") and the operating mode "Defrosting", the button "Standard unit test" is also available. This button opens a selection of tests with fixed parameters. After consultation with the manufacturer, these tests can be performed in order to check the functionality and processes of the freeze-dryer.

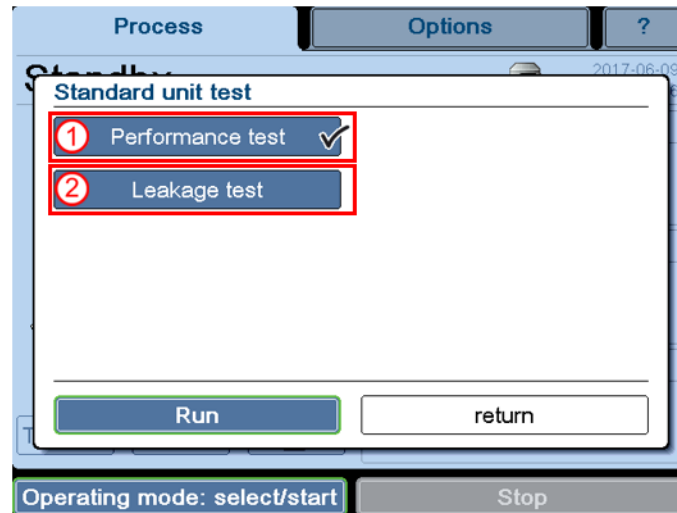

Fig. 28: Dialogue box "Standard unit test"

### Performance test (1)

This test is used to determine the following performance parameters of a freeze-dryer:

- vacuum decrease rate
- final vacuum
- minimum ice condenser temperature



Prior to performing a test, ensure that the chamber is dry and unloaded and that the ice condenser is defrosted!

### Procedure:

- In the main window "Process", select the button "Standard unit test" under "Operating mode: select/start".
- Select "Performance test" and start the test via the "Run" button.

The test will be performed. The parameters will be measured at defined points of time, evaluated, and displayed in a dialog box (see the following illustration).

## 6 Operation

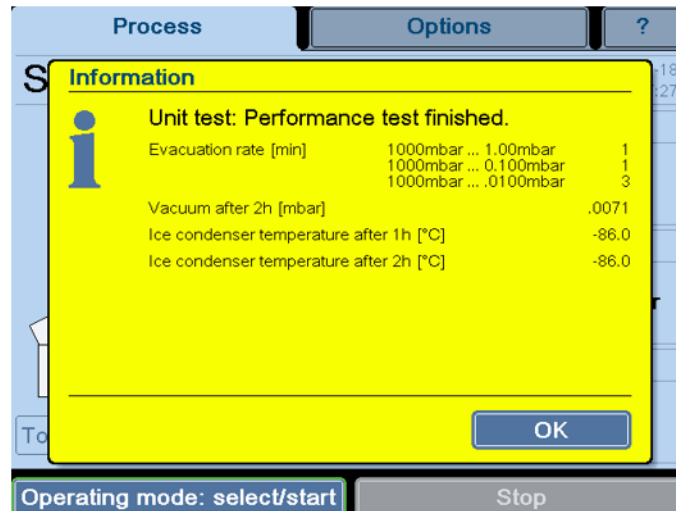

Fig. 29: Results of the performance tests

### Evaluation:

Please contact Martin Christ Gefriertrocknungsanlagen GmbH for an assessment of the results.

### Option: Leakage test (2)

The leakage test is used to test the chamber of the freeze-dryer for tightness in view of any gaseous or liquid media. Since absolutely tight components simply do not exist, a leak rate is determined.

### Procedure:

- In the main window "Process", select the "Set" button to open the dialogue box "Set values: view/edit". Then, select the button "Leakage test".
- Enter the test time (value between 10 min and 18 h) and chamber volume (see the technical data), accept the entries and return to the main window.
- In the main window "Process", select the button "Standard unit test" under "Operating mode: select/start".
- Select "Leakage test" and start the test via the "Run" button.

The parameters for the leakage test have been developed by Martin Christ Gefriertrocknungsanlagen specifically for the freeze-dryers. In a first step, these parameters (vacuum, ice condenser temperature) must be reached. It is not until the conditions are fulfilled that the pressure control valve closes. Then, the actual leakage test is performed in a second step. The result will be indicated by way of a dialogue box.

### Evaluation:

The leak rate that is calculated after the test provides information concerning the tightness of the system. If the threshold value is not reached, the test has been passed. If it is exceeded, the test has been failed.

### Button "Stop" (8)

Pressing this button stops the current process. The freeze-dryer switches to standby.

### 6.5.1.2 Main window "Options"

The main window "Options" is where the basic configuration of the control system is defined. It enables the optimum adaptation of the freeze-dryer to its specific area of application.

#### General

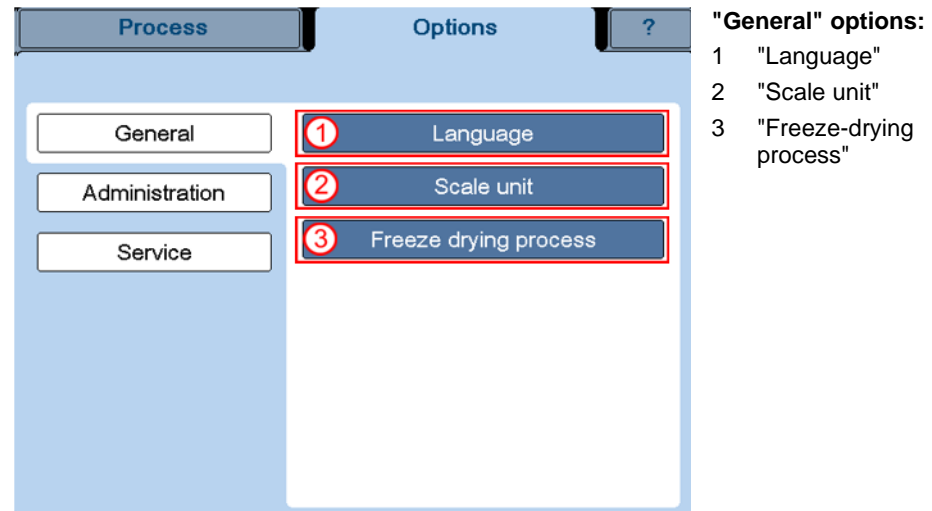

Fig. 30: Overview of the main window "Options/General"

#### Language (1)

The control system can be used in several languages which can be selected via the dialogue box.

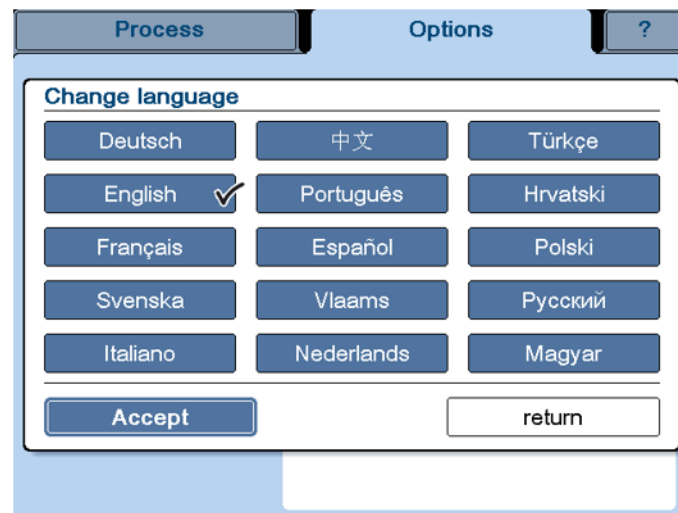

Fig. 31: Dialogue box "Change language"

## 6 Operation

### Scale unit (2)

This dialogue box is used to change the unit of measurement for the temperature and vacuum values.



Fig. 32: Dialogue box "Change scale unit"

### Freeze-drying process (3)



This function depends on the type of freeze-dryer and is not available for all types.

Prior to the start of the process, the correct process must be selected. The following processes are available:

- → *Cold trap operation*<sup>2</sup>: Use of the freeze-dryer as a cold trap
- → *Double-chamber method (outside)*: Drying outside the ice condenser chamber
- *Double-chamber method LyoCube*<sup>3</sup>: Drying outside the ice condenser chamber, but with the CHRIST LyoCube<sup>®</sup> (a rectangular drying chamber that can be loaded from the front)

<sup>2</sup> Not available for Alpha 3-4 LSCbasic.

<sup>3</sup> Not available for Alpha 3-4 LSCbasic.

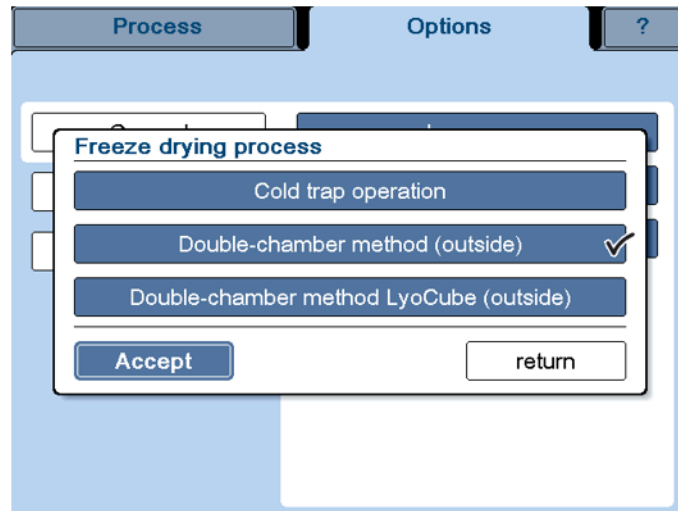
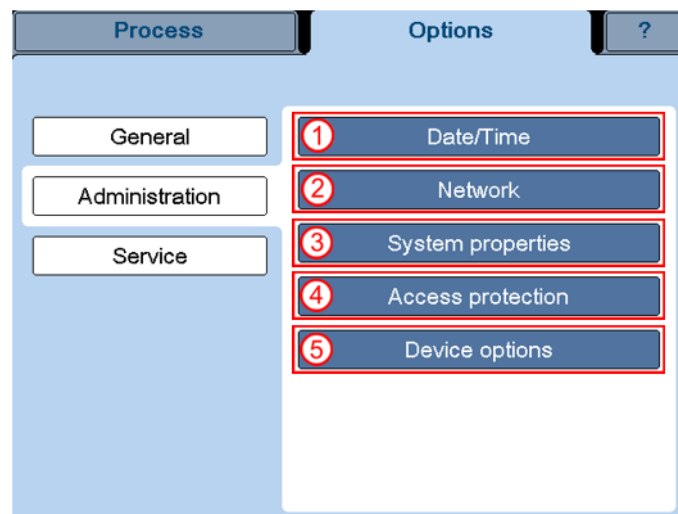

Fig. 33: Dialogue box "Freeze-drying process"

### Administration



**"Administration" options:**

- 1 "Date/Time"
- 2 "Network"
- 3 "System properties"
- 4 "Access protection"
- 5 "Device options"

Fig. 34: Dialogue box "Options" / "Administration"

#### Date/Time (1)

The control system is equipped with an integrated, battery-buffered clock. After a failure of the buffer battery, the date and time must be reset.

## 6 Operation

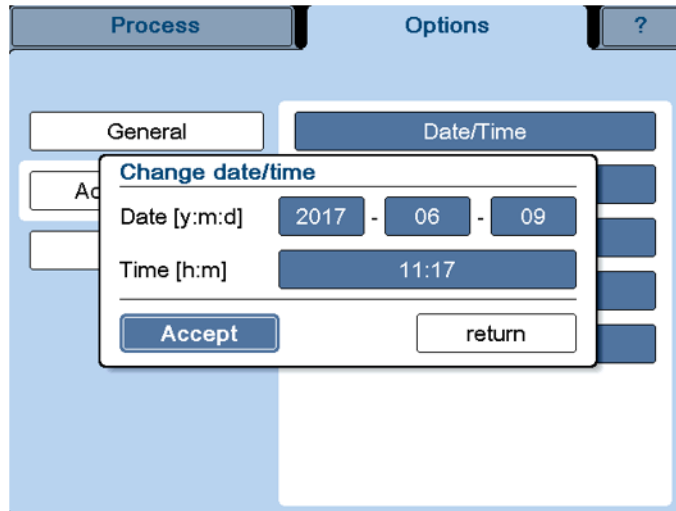

Fig. 35: Dialogue box "Change date/time"

### Network (2)

This dialogue box is used to change the network settings.



The changes will not become effective until after a restart of the freeze-dryer.

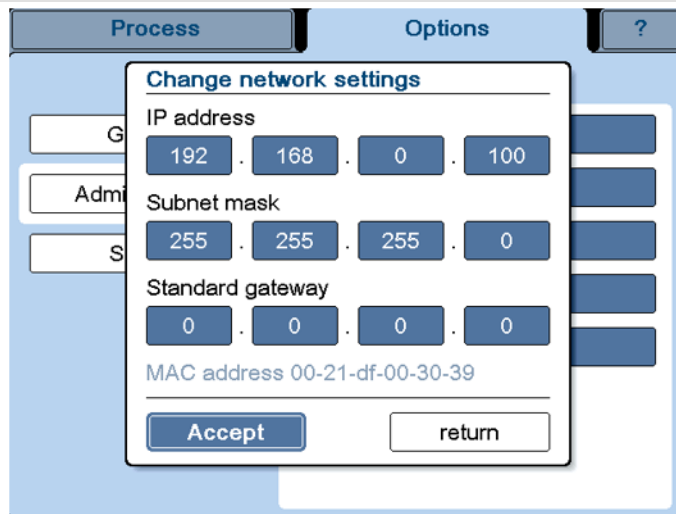

Fig. 36: Dialogue box "Change network settings"



### System properties (3)

This dialogue box is used to change the system settings.

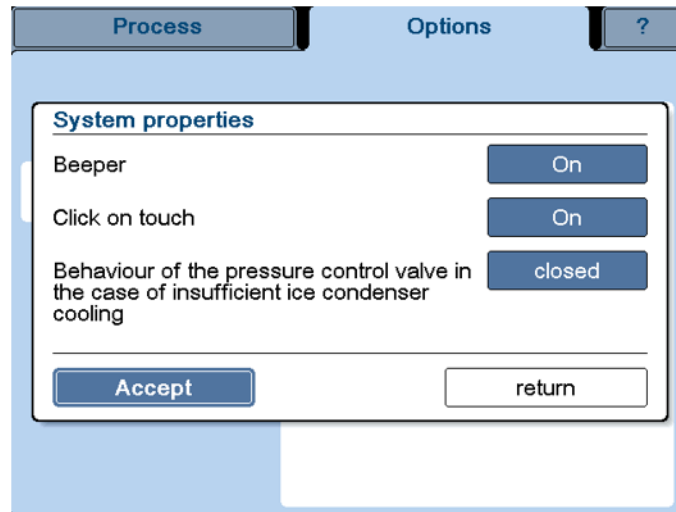

Fig. 37: Dialogue box "System properties"

**Beeper:** The beeper sounds in the event of a malfunction, for example.

- If the setting is "On", the beeper sounds at intervals of a few seconds until the message is acknowledged.
- If the setting is "Silent", the beeper sounds once when the malfunction occurs.
- If the setting is "Off", the beeper will not sound at all.

**Click on touch:** If this function is active, a clicking sound can be heard whenever the system registers that a button has been touched.

**Behaviour of the pressure control valve in the case of insufficient ice condenser cooling:** If this function is active (button "closed"), the pressure control valve will close at an ice condenser temperature of  $\geq 20^{\circ}\text{C}$  during the drying process in order to avoid damage to the vacuum pump caused by the withdrawal of condensable gases. Selecting the button again deactivates the function (button "controlled").

## 6 Operation

### Access protection (4)

In this dialogue box, the access rights can be managed on several levels and they can be protected with a password.

In the factory setting with activated access protection, data can be viewed but not edited.

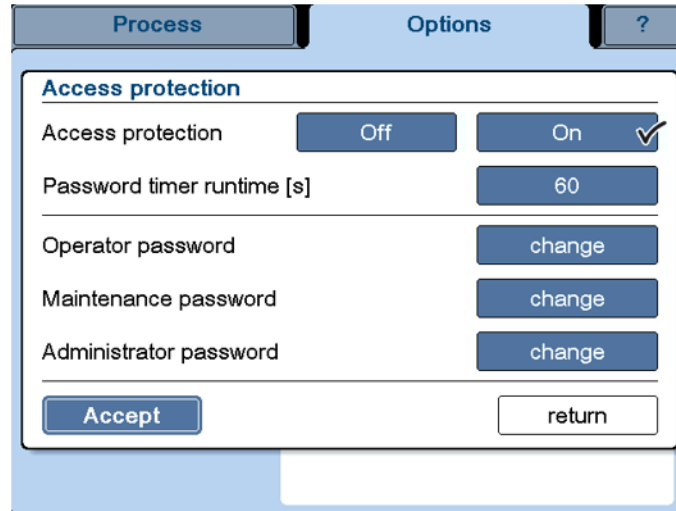

Fig. 38: Dialogue box "Access protection"



**NOTE**

The other buttons cannot be activated unless the access protection is active.

**Password timer runtime:** In order to prevent unauthorised access, the system will automatically switch back to the default setting after a pre-defined period of time.

In this case, there is a small lock symbol in the status line and below this symbol the remaining time until the lock will be active is counted down. At the same time, a button with a big lock symbol will be displayed under the status line.

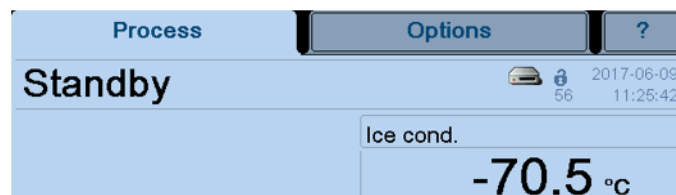

Fig. 39: Countdown of the password timer and the button with the lock symbol

- The button with the lock symbol blocks any access immediately and the system switches to the default setting.

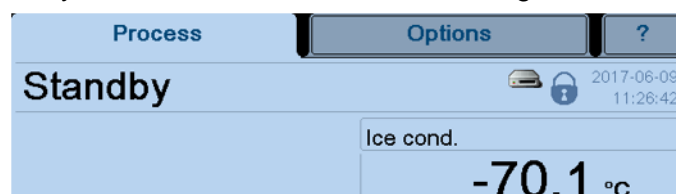

Fig. 40: Access blocked, data editing not possible

*Operator/maintenance/administrator password:* For each of these access levels, certain editing rights have been defined. They can be enabled with the corresponding password.

The rights of the various access levels are detailed in the following table.

Action	Operator	Service	Administrator
Editing of the data of the current process run (e.g. selection of the operating mode, changing of set values)	✓	✓	✓
Editing of maintenance functions (e.g. oil change of the vacuum pump)	--	✓	✓
Editing of the default settings (e.g. editing of the access protection configuration, creating and editing of programs, editing of system settings)	--	--	✓

### Device options (5)

This dialogue box lists all of the device options that are available for the freeze-dryer in question. A list of all the possible options can be found at chapter 6.6 - "Optional extensions". Options that require a series-number-specific release code are marked with the symbol "🔒".

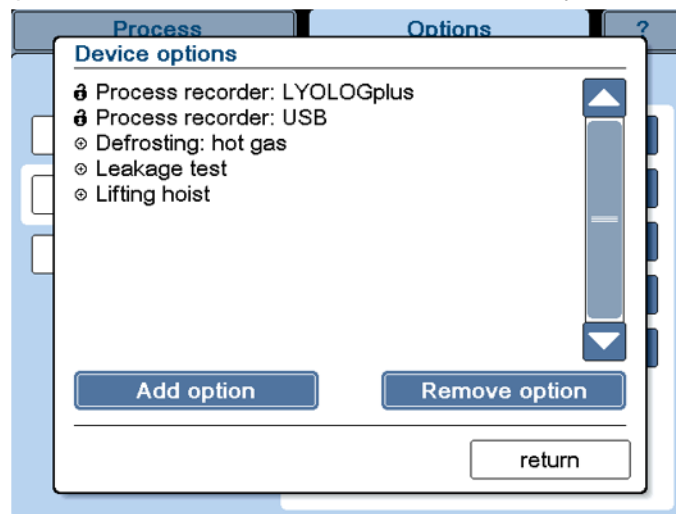

Fig. 41: Dialogue box "Device options" (example)

If the freeze-dryer is to be extended by an option, this option must be enabled via this dialogue box.

- Select the button "Add option". An input window opens.
- Enter the six-digit CHRIST activation code that was supplied for this option. Note that the code is case-sensitive.

Options can be removed in the same way.



The changes will not become effective until after a restart of the freeze-dryer.

## 6 Operation

### Later installation of a vacuum sensor

In freeze-dryers that have been delivered without a vacuum sensor, the device option "Sensor: vacuum not installed" is activated at the factory in order to suppress error messages during operation.

If a vacuum sensor is installed at a later time, this option must be deactivated as described hereinabove.

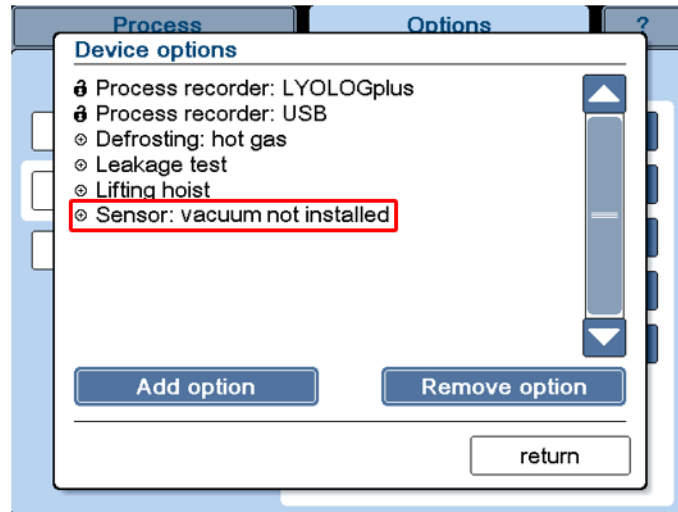
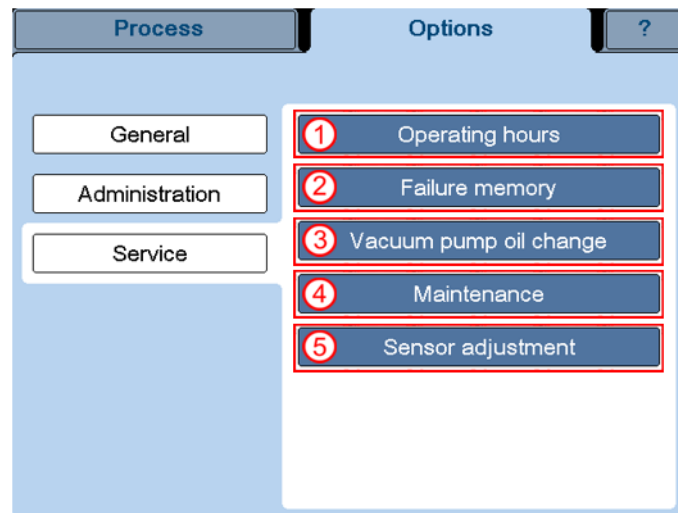

Fig. 42: Device option "Sensor: vacuum not installed"

### Service



#### "Service" options:

- 1 "Operating hours"
- 2 "Failure memory"
- 3 "Vacuum pump oil change"
- 4 "Maintenance"
- 5 "Sensor adjustment"

Fig. 43: Dialogue box "Service" (varies depending on the type of freeze-dryer)

#### Operating hours (1)

This dialogue box is used to view the number of operating hours of the various components of the freeze-dryer, e.g. the refrigeration unit, vacuum pump or pressure control valve. In addition to the name, the respective → *reference designation* is also displayed.

These data are provided for informational purposes only. They cannot be edited.

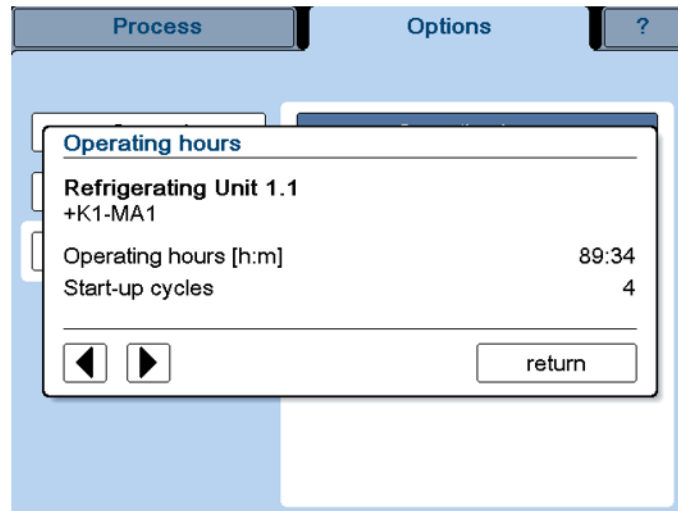

Fig. 44: Dialogue box "Operating hours" (here: refrigeration unit 1.1)

### Failure memory (2)

The failure memory stores the most recent messages of the process and equipment information system. The messages can be viewed in this dialogue box. The failure memory includes the last 32 messages. If this number is exceeded, the oldest message will be overwritten.

Use the arrow keys to select the individual messages.

The error message text is always followed by an error code.



Always indicate the error code in the event of enquiries or service requests!

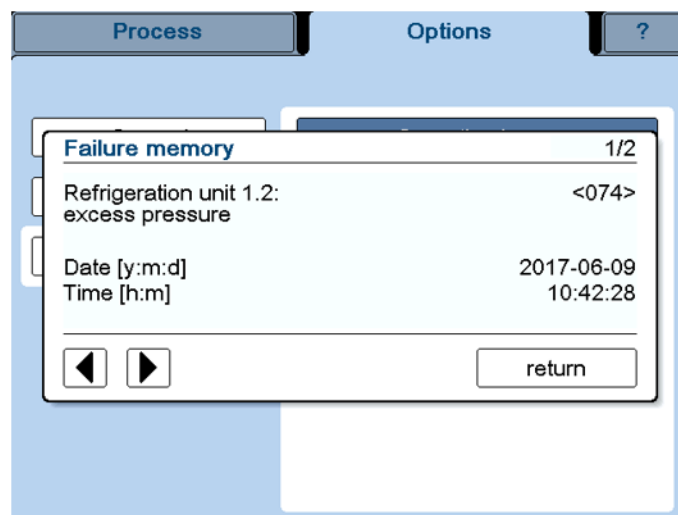

Fig. 45: Dialogue box "Failure memory"

### Vacuum pump oil change (3)

The system monitors the oil change interval of the vacuum pump. The interval can be adapted to the vacuum pump model and utilisation.

When the end of an oil change interval is reached, a corresponding message will be displayed.

## 6 Operation

- Acknowledge the message.
- Change the oil of the vacuum pump.
- Reset the operating hour counter in the dialogue box "Vacuum pump oil change" by way of the "reset" button.

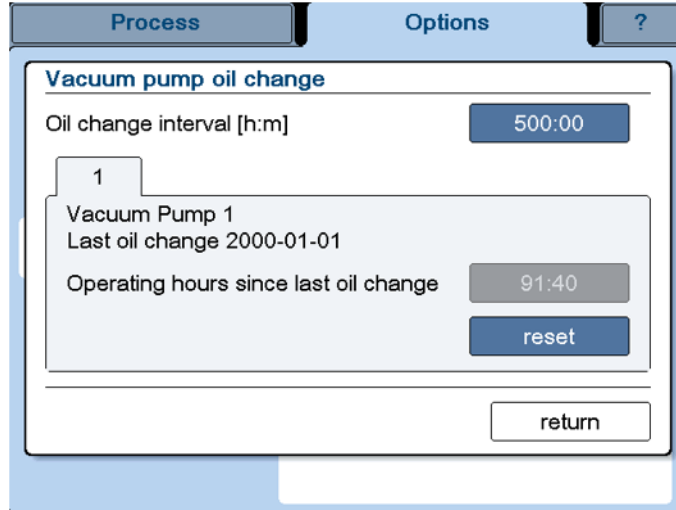

Fig. 46: Dialogue box "Vacuum pump oil change"

### Maintenance (4)

The maintenance interval of the freeze-dryer is set at 3,000 operating hours or at least one maintenance per year.

When the end of a maintenance interval is reached, a corresponding message will be displayed.

- Acknowledge the message.
- Make an appointment for the maintenance of your freeze-dryer.
- After the maintenance, our service engineer will reset the operating hour counter in the dialogue box "Maintenance".

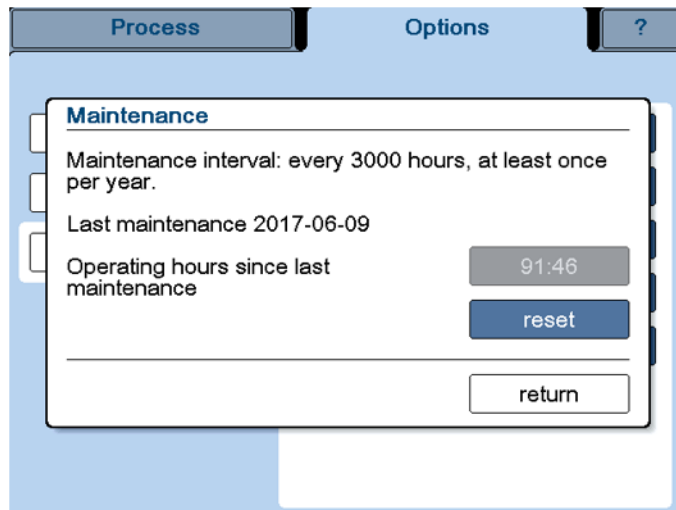

Fig. 47: Dialogue box "Maintenance"

**Sensor adjustment (5)**

In this dialogue box, the sensors are adjusted based on a predefined reference value.

**CAUTION**

Sensors that are not properly adjusted will lead to incorrect measurements which, in turn, will have a negative effect on the process control.

**NOTE**

Only specialised personnel are authorised to perform the sensor adjustment.

## 6 Operation

### 6.5.1.3 Main window "?"

This main window includes the most important information concerning your freeze-dryer:



Fig. 48: Freeze-dryer system information (example)



In the event of enquiries at the manufacturer, please state the data that is stated here.

### 6.5.2 Starting a freeze-drying process

Freeze-drying processes are started in the main window "Process".



Prior to any freeze-drying process, the correct method must be selected (chapter 6.5.1.2 - "Main window "Options"", "Freeze-drying process (3)").

The set values for the individual process phases ("Freezing", "Warm-up", "Main drying" and "Final drying") are defined prior to the start of the process (see chapter 6.5.2.1 - "Entering set values"). Then, the freeze-drying process can be started via the dialogue box "Operating mode: select/start".



If the freeze-drying process is to be started directly with the "Main drying" phase, the vacuum pump must be warmed up approximately 15 minutes prior to the process start. Failure to do so will result in a corresponding warning message when the process starts.



**i**  
**NOTE**

If the value " $\infty$ " (infinite) is selected for a process phase, the next phase must be started manually via the button "Operating mode: select/start".

The set values of the active phase can be changed during the process run. In this case, the control system adapts the freeze-dryer to the new set values as quickly as possible.

After the completion of a phase, the freeze-dryer switches to the next phase without switching to standby. The transition from "Freezing" to "Warm-up" takes place automatically. After the completion of the "Warm-up" phase, a dialogue box opens:

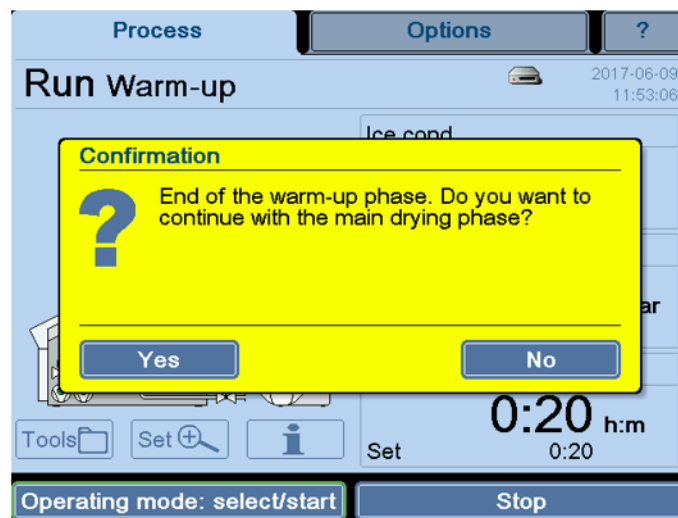

Fig. 49: Dialogue box after the completion of the warm-up phase

The freeze-dryer will remain in the "Warm-up" phase until a confirmation is issued.

Normally, the transition from "Main drying" to "Final drying" takes place automatically.

After the completion of the "Final drying" phase, there will be another enquiry with which the freeze-drying process will be completed. The freeze-dryer remains in the "Run" mode until the enquiry is confirmed.

The process can be stopped any time by way of the "Stop" button. In this case, the freeze-dryer will be switched to standby.

### 6.5.2.1 Entering set values

The system has stored set values for every phase, and for every value there are pre-defined value ranges that can be determined in the various dialogue boxes by pressing the buttons "min" and "max".

In order to protect the product, a  $\rightarrow$  *safety pressure* value can be entered in every drying section.

## 6 Operation

### Viewing or editing the set values:

- Press the button "Set" (see chapter 6.5.1.1 - "Main window "Process"). The following dialogue box will be displayed:

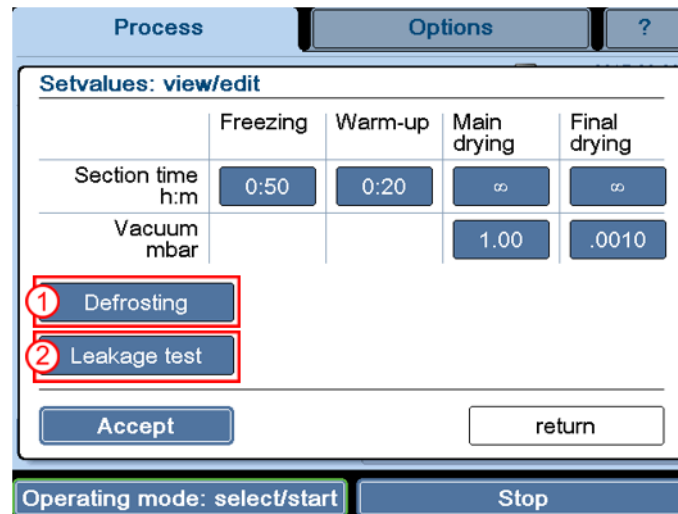

- "Defrosting" button
- "Leakage test" button (option)

Fig. 50: Dialogue box "Set values: view/edit"

Fields that are displayed in the form of buttons can be edited.

- Defrosting (1)  
This button is used to pre-define the defrosting time and temperature.
- Leakage test (2)  
This button displays the parameters that are used for the leakage test. In addition, the test time and the chamber volume must be stated (depending on the accessories that are used).

Numerical values can be edited with the aid of a numerical keypad:

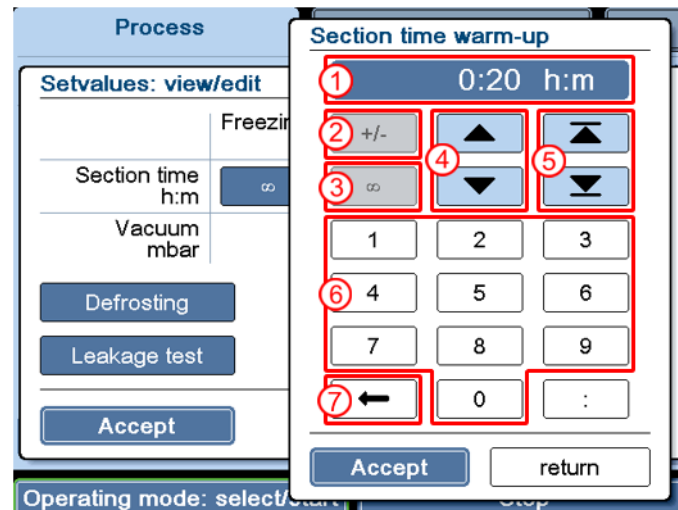

- Set value display
- Button for changing the sign (e.g. when entering temperature values)
- "∞" (infinite)
- Button for editing the value in pre-defined steps
- Selection of a possible maximum or minimum value
- Input of a value via the numerical keypad
- Button for deleting the displayed value

Fig. 51: Editing set values

- Confirm the new value and quit the numerical keypad by pressing the button "Accept".
- Confirm the input and quit the dialogue box via the button "Accept".



If the dialogue box is closed by the button "return", the changes will be discarded.

## 6.6 Optional extensions

The basic unit is extendable with the following optional functions:

### **Leakage test**

see also chapter 6.5.2.1 - "Entering set values" and chapter 6.5.1.1 - "Main window "Process"", dialogue box "Operating mode: select/start" (7), button "Standard unit test"

The leakage test enables the chamber of the freeze-dryer to be tested for tightness in view of any gaseous or liquid media. Since absolutely tight components simply do not exist, a leak rate is determined. The parameters for the leakage test have been developed by Martin Christ Gefrier-trocknungsanlagen specifically for freeze-dryers. In a first step, these parameters (vacuum, ice condenser temperature) must be reached. It is not until the conditions are fulfilled that the pressure control valve closes. Then, the actual leakage test is performed in a second step. The leak rate that is calculated after the end of the test provides information concerning the tightness of the system.

### **USB process recorder**

see also chapter 6.5.1.1 - "Main window "Process"", dialogue box "Tools"

This feature enables the recording of a running process on a USB storage medium. After the end of the process recording, the process data can be viewed on the PC with LyoLogplus and be printed. It is also possible to import the data directly into an Excel file.

### **LyoLogplus data logging software**

LyoLogplus is a data logging software program by Martin Christ Gefriertrocknungsanlagen GmbH that is specifically adapted to the requirements of freeze-drying processes. Apart from the graphical representation of the measurement data of currently running processes, it also enables the data export for additional evaluation.

## 6.7 Switching the freeze-dryer OFF

The freeze-dryer must be in the standby status.

- Switch the freeze-dryer off by pressing the mains switch.

## 7 Malfunctions and error correction

### 7 Malfunctions and error correction

Malfunctions are displayed in the dialogue box "Process & equipment messages" (see chapter 7.2 - "Process and error messages"). An acoustic signal sounds when an error message is generated.

- Eliminate the source of the problem (see the following chapter).
- Acknowledge the error message.

#### 7.1 General malfunctions

Type of error	Possible reason	Correction
<b>No indication on the display</b>	<ul style="list-style-type: none"> <li>• No power in the mains supply (see chapter 7.1.1 - "Power failure").</li> <li>• Power cord is not plugged in.</li> <li>• Fuses have tripped.</li> <li>• The mains power switch is set to off.</li> </ul>	<ul style="list-style-type: none"> <li>• Check the mains power supply fuse.</li> <li>• Plug in the power cord correctly.</li> <li>• Check the on-site fuses</li> <li>• Switch mains power switch ON.</li> </ul>
<b>The touchpanel does not react at all or it does not react correctly</b>	<ul style="list-style-type: none"> <li>• The sensitivity of the touchpanel is misadjusted.</li> </ul>	<ul style="list-style-type: none"> <li>• Contact the service department (see chapter 7.3 - "Service contact")</li> </ul>
<b>The password input fails</b>	<ul style="list-style-type: none"> <li>• The password is not correct.</li> </ul>	<ul style="list-style-type: none"> <li>• Inform the administrator.</li> <li>• If you have lost the administrator password: contact the service department (see chapter 7.3 - "Service contact")</li> </ul>
<b>Insufficient vacuum</b>	<ul style="list-style-type: none"> <li>• Incorrect connection of the small flange connection(s).</li> </ul>	<ul style="list-style-type: none"> <li>• Loosen the connection. Place the centring ring with the inner sealing ring in a centred manner between the flange connections and connect it with the clamping ring. Ensure that the centring ring neither slips out of place nor gets jammed.</li> </ul>
	<ul style="list-style-type: none"> <li>• Dirty or damaged lid or door seal.</li> </ul>	<ul style="list-style-type: none"> <li>• Clean the lid or door seal and replace it if necessary.</li> </ul>
	<ul style="list-style-type: none"> <li>• The ground-in stopper of the attached drying chamber is not installed correctly.</li> </ul>	<ul style="list-style-type: none"> <li>• Grease the ground-in stopper evenly and over the entire sealing surface with vacuum grease.</li> </ul>
<b>Leakage in the media drain valve</b>	<ul style="list-style-type: none"> <li>• The media drain valve is soiled with drying residues or wool particles from cleaning cloths.</li> <li>• The O-rings are worn</li> </ul>	<ul style="list-style-type: none"> <li>• Clean the media drain valve (see chapter 8.1.3 - "Aeration valve, media drain valve") and replace it if necessary.</li> <li>• Replace the O-rings.</li> </ul>
<b>Leakage in a rubber valve</b>	<ul style="list-style-type: none"> <li>• The valve is soiled.</li> </ul>	<ul style="list-style-type: none"> <li>• Check the valves individually (see chapter 7.1.2.4 - "Rubber valves")</li> </ul>

## 7 Malfunctions and error correction

Type of error	Possible reason	Correction
The displayed vacuum value is not correct	<ul style="list-style-type: none"> <li>• Incorrect calibration</li> <li>• The vacuum sensor is soiled (e.g. due to water residues)</li> <li>• The vacuum sensor is defective.</li> </ul>	<ul style="list-style-type: none"> <li>• Calibrate the vacuum sensor (see the separate operating instructions of the vacuum sensor).</li> <li>• Clean the vacuum sensor.</li> <li>• Check the vacuum display with the aid of a reference device (if available).</li> <li>• see (see chapter 7.1.2.5 - "Vacuum sensor")</li> </ul>
The vacuum pump is not activated	<ul style="list-style-type: none"> <li>• See the separate operating instructions of the vacuum pump.</li> </ul>	<ul style="list-style-type: none"> <li>• See the separate operating instructions of the vacuum pump.</li> </ul>
Insufficient ice condenser or shelf temperature	<ul style="list-style-type: none"> <li>• The overpressure switch of the refrigeration unit has tripped.</li> <li>• The thermal circuit breaker has tripped.</li> </ul>	<ul style="list-style-type: none"> <li>• Let the unit cool down.</li> <li>• Ensure sufficient air circulation (see chapter 7.1.3 - "Insufficient ice condenser temperature")</li> </ul>
The error message "Refrigeration unit x.x overpressure" is displayed during a freeze-drying process	<ul style="list-style-type: none"> <li>• Leakage on the low pressure side (suction side) of the refrigeration system leads to a pressure increase</li> </ul>	<ul style="list-style-type: none"> <li>• Acknowledge the message. If the message is displayed repeatedly, inform the service department (see chapter 7.3 - "Service contact")</li> </ul>



If it is impossible to eliminate the errors, contact the Christ service department!

### 7.1.1 Power failure

The control system continues with the process after a power failure. The preselected conditions remain saved even during a process run.

In the event of a power failure in the drying phase, the batch may become unusable. Whether the batch can be saved or not depends on the drying phase in which the product was when the power failure occurred.

- In the final drying phase, the product has reached a residual moisture content of approx. 5%. Below this value, the product is generally not damaged even if the power failure lasts for a longer period of time.
- If the product is in the main drying phase, we recommend aerating the unit, removing the product, and storing it in a deep-freeze. The defrosted condensate must be drained off prior to the next start.

## 7 Malfunctions and error correction

### 7.1.2 Insufficient vacuum



The vacuum checks must be carried out when the ice condenser is frozen.

#### 7.1.2.1 Small flange connections

Leakages are often due to improper small flange connections between the various components and hose connections or to leakages in the valves.

- Loosen the connection and place the centring ring (with sealing ring inside) in a centred manner between the flange connections.
- Seal the connection with the clamping ring by tightening the wing nut.
- Ensure that the centring ring neither slips out of place nor gets jammed.

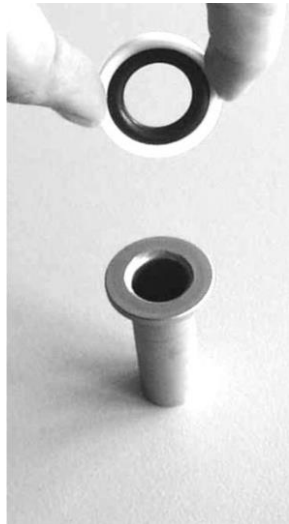

Fig. 52: Small flange and centring ring



Fig. 53: Small flange with centring ring and small flange



Fig. 54: Attaching the clamping ring



Fig. 55: Tightened clamping ring

**7.1.2.2 Aeration valve, media drain valve****WARNING****Risk of poisoning/infection caused by contaminated condensate (defrosting water)**

The condensate may contain harmful substances originating from the product.

Contact with the condensate may cause severe damage to health.

- Wear suitable protective clothes, gloves, and respiratory protection when performing any work on the drain system (especially when cleaning the valves and replacing the seals)!

A malfunction of the aeration valve or the media drain valve may have several causes. One potential source are contaminants such as product residues within the valve.

- Switch the freeze-dryer off and disconnect the mains plug.
- Clean the valve (see chapter 8.1.3 - "Aeration valve, media drain valve").
- Put the freeze-dryer into operation again.

If there is still a leakage, the freeze-dryer must be checked by qualified specialist personnel (see chapter 7.3 - "Service contact").

**7.1.2.3 Pressure control valve**

A malfunction of the pressure control valve may have several causes.

**NOTE**

The inspection of the valve must be carried out by qualified specialist personnel (see chapter 7.3 - "Service contact").

**7.1.2.4 Rubber valves**

In order to identify a leaking rubber valve, the valves must be checked individually:

- Remove the rubber valve and seal the connection at the drying chamber with a rubber stopper.
- Check the tightness under vacuum until the leaking valve has been localised.
- Clean the valve or replace it if necessary.

**7.1.2.5 Vacuum sensor**

Vacuum sensors have a limited service life and can be ordered as spare parts.

**Capacitive vacuum sensors**

Capacitive vacuum sensors may experience a measurement drift due to long-term use, soiling or sudden aeration. In this case, the vacuum sensor must be adjusted (see chapter 8.1.9 - "Vacuum sensor").

## 7 Malfunctions and error correction

---

### 7.1.3 Insufficient ice condenser temperature



#### CAUTION

Ensure sufficient ventilation. Do not place any paper, cloth, or similar material behind or under the unit, since otherwise the air circulation will be impaired.

The refrigeration unit is equipped with a protective device against overpressure in the refrigeration system and with a thermal motor protection switch.

The protective devices trip

- when the ambient temperature is too high
- when the air circulation of the heat exchanger of the refrigeration system is insufficient
- when the refrigeration system is overloaded.

In these cases, the refrigeration unit will be switched off automatically. If the permissible operating conditions are re-established after a cool-down phase of several minutes, the refrigeration unit will be switched on again automatically.

The malfunctions are displayed in the process and equipment information window.

The minimum ice condenser temperature of approx.  $-55^{\circ}\text{C}$  or approx.  $-85^{\circ}\text{C}$  (depending on the type of freeze-dryer) is reached when the ice condenser is not loaded and the ice condenser chamber is evacuated.

## 7.2 Process and error messages

The control system displays the complete process and error messages (see chapter 6.5.1.1 - "Main window "Process"", dialogue box "Process and equipment messages"), which is why they are not included in this operating manual.

You can order these documents from our service department.



### 7.3 Service contact

In the event of queries, malfunctions, or spare part enquiries:

**From Germany:**

Contact

Martin Christ Gefriertrocknungsanlagen GmbH  
An der Unteren Söse 50  
37520 Osterode (Germany)  
Tel. +49 (0) 55 22 / 50 07-44 44  
E-mail: [support.lab@martinchrist.de](mailto:support.lab@martinchrist.de)

**Outside Germany:**

Contact our agency in your country. All agencies are listed at  
[www.martinchrist.de](http://www.martinchrist.de) → [Sales Partners]



If you would like to utilise our after-sales-service, please state the type of your freeze-dryer and its serial number.

## 8 Maintenance and service

---

### 8 Maintenance and service

The freeze-dryer and the accessories are subject to high mechanical and chemical stress. Thorough maintenance performed by the user extends the service life and prevents premature failure.



#### CAUTION

If corrosion or other damage occurs due to improper care, the manufacturer cannot be held liable or subject to any warranty claims.

- Thoroughly clean the freeze-dryer immediately after use to prevent or at least significantly reduce the damage to the materials of construction (see also chapter 1.2 - "Intended use", section "Freeze-drying of solvent-containing products").
- Use soap water or other water-soluble, mild cleaning agents for cleaning the freeze-dryer and the accessories.
- Do not use corrosive and aggressive substances.
- Do not use solvents.
- Do not use agents with abrasive particles.
- Do not expose the freeze-dryer or its accessories to intensive UV radiation (e.g. sunlight) or thermal stress (e.g. by heat generators).
- Do not turn the unit upside down in order to clean it.

### 8.1 Maintenance

#### 8.1.1 General

The general state of the freeze-dryer must be checked at regular intervals. Any defects must be eliminated immediately! The following points are of particular importance:

- dirt
- leaks
- corrosion
- bent system components
- loose screw and flange connections
- higher noise levels
- loose cables
- open cable ducts
- missing or illegible safety notes and hazard warnings
- missing or illegible inscriptions on components, pipes (direction of flow) and cables
- etc.

**Cleaning of the freeze-dryer**

- Switch the freeze-dryer off by actuating the mains power switch and disconnect the power cord from the wall outlet before cleaning.
- If the freeze-dryer has been contaminated with toxic, radioactive, or pathogenic substances, clean the inside immediately with a suitable decontamination agent (depending on the type of contamination, see chapter 8.2 - "Disinfection of the drying chamber and accessories").
- Remove product residues thoroughly with a cloth.
- Open the lid/drying chamber when the freeze-dryer is not in use so moisture can evaporate.

**8.1.2 Ice condenser chamber**

Before each start-up, ensure that the ice condenser chamber is free from water residues.

- Open the media drain valve to drain off any liquid. Then, close the valve.
- If necessary, wipe the ice condenser chamber dry with a cloth.

## 8 Maintenance and service

### 8.1.3 Aeration valve, media drain valve



**WARNING**

#### **Risk of poisoning/infection caused by contaminated condensate (defrosting water)**

The condensate may contain harmful substances originating from the product.

Contact with the condensate may cause severe damage to health.

- Wear suitable protective clothes, gloves, and respiratory protection when performing any work on the drain system (especially when cleaning the valves and replacing the seals)!

Contaminants such as product residues may lead to an insufficient vacuum. In this case, the aeration valve and the media drain valve must be cleaned.

- Switch the freeze-dryer off and disconnect the mains plug.
- Remove the valve core.
- Clean the valve core and the opening with a moist cloth.
- Clean the O-rings and inspect them for any damage. Damaged O-rings must be replaced.

- 1 Valve opening
- 2 Valve core
- 3 O-rings

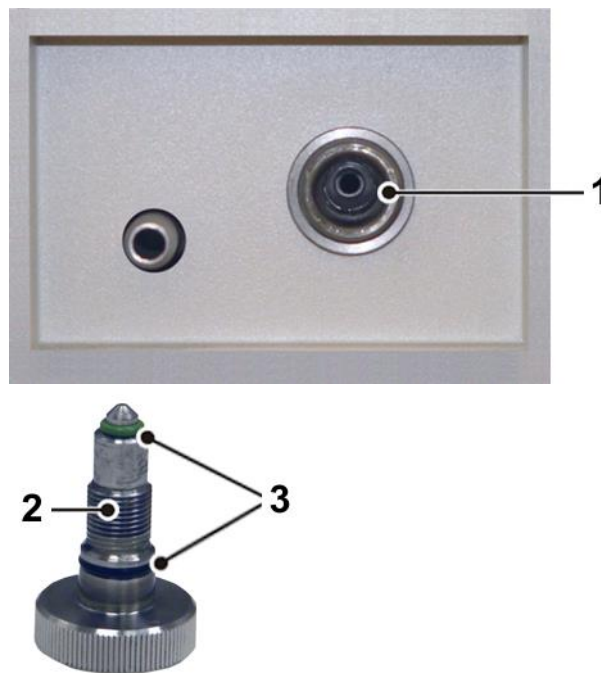

*Fig. 56: Valve opening and valve core with O-rings  
(example, varies depending of the type of freeze-dryer)*

- Reinsert the valve core.
- Put the freeze-dryer into operation again.

If the vacuum is still insufficient, the freeze-dryer must be checked by qualified specialist personnel (see chapter 7.3 - "Service contact").

### 8.1.4 Heat exchanger (only for air-cooled freeze-dryers)

A lamellar heat exchanger is used for cooling the refrigerant that is compressed by the refrigeration unit. This air-cooled heat exchanger is located at the back of the unit (see chapter 2.1.1 - "Functional and operating elements").

Dust and dirt impair the cooling effect of the air flow. Dust on the lamellas prevents the exchange of heat and, thereby, impairs the performance and power of the refrigeration unit. Strong soiling may cause the unit to fail.

This is why the selected set-up location should be as clean as possible.

- Check the heat exchanger at least once per month for soiling and clean it if necessary.
- Please contact the Christ service department if you have any queries (see chapter 7.3 - "Service contact").

### 8.1.5 Electrical system



**DANGER**

#### **Danger of life caused by electric shock**

There is a risk of electric shock when touching current-carrying components.

This may lead to ventricular fibrillation, cardiac arrest, or respiratory paralysis.

- Only qualified electricians are authorised to perform work on the electrical system of the freeze-dryer!

The electrical equipment of the freeze-dryer must be checked at regular intervals by a qualified electrician. Defects such as loose connections or burnt cables must be eliminated immediately.

## 8 Maintenance and service

### 8.1.6 Vacuum pump



Please refer to the separate operating manual of the vacuum pump!

The stress of the vacuum pump in conjunction with a freeze-dryer is usually not very high. This is why the recommendations in this operating manual may differ from the information that is provided by the pump manufacturers. Under normal operating conditions, the following maintenance tasks concerning the vacuum pump must be performed at regular intervals:

- Check the oil level of the vacuum pump once per week. If necessary, top it up with oil.
- Check the running pump for any unusual noise.
- Ensure that the pump has reached its operating temperature prior to changing the oil.
- Perform the first oil change after approximately 100 operating hours.
- The other oil changes depend on the operating conditions. In general, an interval of 500 to 1,000 operating hours is sufficient.
- Please contact the Christ service department if you have any queries (see chapter 7.3 - "Service contact").

### 8.1.7 Exhaust filter (oil mist separator)



Please refer to the separate operating manual of the vacuum pump and the exhaust filter!

The oil mist that is emitted by the vacuum pump in quantities that depend on the working pressure must be led to the outside or to an exhaust hood or similar. If this is not possible, the pump must be equipped with an exhaust filter (oil mist separator).

- Observe the liquid level in the collecting vessel of the filter.
- Remove the condensate in time (please refer to the information provided by the manufacturer in the separate operating manual).

### 8.1.8 Refrigeration system



**DANGER**

#### **Risk of explosion due to refrigerants (natural, flammable refrigerants)**

The natural refrigerants used are highly flammable and can form an explosive mixture if their concentration in the ambient air is sufficiently high.

There is an explosion hazard.

- Work on the refrigeration system of the freeze-dryer must only be carried out by qualified specialist personnel who have been trained to handle flammable refrigerants!
- Ensure good ventilation and make sure that no ignition sources (e.g. soldering iron, welding equipment) are present!



**WARNING**

#### **Risk of cold burns or frostbite caused by the refrigerant**

When work is performed on the refrigeration system of the freeze-dryer, refrigerant may escape in the liquid or gas state and under high pressure. In the case of skin contact with liquid refrigerant, cold burns or frostbite may result.

- Only qualified persons are authorised to perform work on the refrigeration system of the freeze-dryer!



**WARNING**

#### **Risk of poisoning caused by the refrigerant (non-flammable refrigerants)**

During its decomposition (e.g. due to naked flames or hot surfaces), hazardous/toxic gases are released.

Contact with the decomposition products may cause severe damage to health.

- Only qualified persons are authorised to perform work on the refrigeration system of the freeze-dryer!
- Do not eat, drink, or smoke when working on the refrigeration system!

The refrigerant circuit is a closed system. Only certified and qualified persons are authorised to perform work on the refrigeration system!

### 8.1.9 Vacuum sensor



**NOTE**

Please refer to the separate operating manual of the vacuum sensor!

The vacuum sensor has only a limited service life. Especially carbon-containing substances, e.g. alcoholic compounds, reduce the service life extremely.

- The vacuum sensor is maintenance-free.
- Remove any soiling on the outside with a cloth.

## 8 Maintenance and service

### Capacitive vacuum sensors

Measurement drift due to long-term use, soiling or sudden aeration may occur.

- Capacitive vacuum sensors must be adjusted at least once per year. Depending on the actual conditions of use, shorter adjustment intervals may be necessary.

### 8.1.10 Accessories



#### CAUTION

For the care of the accessories, special safety measures must be considered as these are measures that will ensure operational safety at the same time.

Chemical reactions as well as stress-corrosion (combination of oscillating pressure and chemical reaction) can affect or destroy the metal and plastic parts. Barely detectable cracks on the surface can expand and weaken the material without any visible signs.

- Check the material regularly (at least once a month) for
  - cracks
  - visible damage of the surface
  - pressure marks
  - signs of corrosion
  - other changes.
- Replace any damaged components immediately for your own safety.
- Immediately rinse off the accessories if any liquids that may cause corrosion come into contact with them.
- Clean the accessories outside the freeze-dryer once a week or preferably after each use.

## 8.2 Disinfection of the drying chamber and accessories



#### DANGER

If dangerous materials (e.g. infectious and pathogenic substances) are used, the freeze-dryer and accessories must be disinfected.

- Use commercially-available disinfectants such as, for example, Incidur<sup>®</sup>, Meliseptol<sup>®</sup>, Sagrotan<sup>®</sup>, Buraton<sup>®</sup>, or Terralin<sup>®</sup> (available at specialised trade).
- The freeze-dryers and the accessories consist of various materials. A possible incompatibility must be considered.
- Before using cleaning or decontamination agents that were not recommended by us, contact the manufacturer to ensure that such a procedure will not damage the freeze-dryer.



- Please contact us if you have any queries (see chapter 7.3 - "Service contact").

### 8.3 Service



**DANGER**

In the event of service work that requires the removal of the panels, there is a risk of electric shock or mechanical injury. Only qualified specialist personnel is authorised to perform this service work.

The freeze-dryer is subject to high mechanical stress. In order to be able to withstand this high level of stress, high-quality components were used during the production of the freeze-dryer. Nevertheless, wear cannot be excluded and it may not be visible from the outside.

This is why we recommend having the freeze-dryer checked by the manufacturer during an inspection once per year.

Information and appointments:

**From Germany:**

Contact

Martin Christ Gefriertrocknungsanlagen GmbH

An der Unteren Söse 50

37520 Osterode (Germany)

Tel. +49 (0) 55 22 / 50 07-44 44

E-mail: [support.lab@martinchrist.de](mailto:support.lab@martinchrist.de)

**Outside Germany:**

Contact our agency in your country. All agencies are listed at

[www.martinchrist.de](http://www.martinchrist.de) → [Sales Partners]



**NOTE**

If you would like to utilise our after-sales-service, please state the type of your freeze-dryer and its serial number.

### 8.4 Return of defective parts

Although we exercise great care during the production of our products, it may be necessary to return a unit or accessory to the manufacturer.

In order to ensure the quick and economical processing of returns of freeze-dryers, rotational vacuum concentrators, spare parts, or accessories, we require complete and extensive information concerning the process. Please fill in the following forms completely, sign them, enclose them with the return package, and send them together with the product to:

## 8 Maintenance and service

---

Martin Christ Gefriertrocknungsanlagen GmbH  
An der Unteren Söse 50  
37520 Osterode (Germany)

### 1. Declaration of decontamination

As a certified company and due to the legal regulations for the protection of our employees and of the environment, we are obliged to certify the harmlessness of all incoming goods. For this purpose, we require a declaration of decontamination.

- The form must be filled in completely and signed by authorised specialist personnel only.
- Affix the original form in a clearly visible manner to the outside of the packaging.



We will return the part/unit if no declaration of decontamination is provided!

### 2. Form for the return of defective parts

This form is for the product-related data. They facilitate the assignment, and they enable the quick processing of the return. If several parts are returned together in one packaging, please enclose a separate problem description for every defective part.

- A detailed problem description is necessary in order to perform the repair quickly and economically.
- Upon request, we will prepare and submit to you a cost estimate prior to performing the repair. Please confirm such cost estimate within 14 days. If the cost estimate has still not been confirmed after 4 weeks, we will return the defective part/unit. Please note that you must bear the incurred costs.



The part/unit must be packaged in a transport-safe manner. Please use the original packaging for the unit, if at all possible.

If the product is dispatched to us in unsuitable packaging, you will be charged the cost for returning it to you in new packaging.

The forms can be downloaded online from  
[www.martinchrist.de](http://www.martinchrist.de) → [Service] → [Overhaul, repair and leak testing].

## **9 Disposal**

### **9.1 Disposal of the freeze-dryer**

Martin Christ Gefriertrocknungsanlagen GmbH is a registered manufacturer of electric and electronic devices that are solely intended for commercial use.

- Comply with all local rules and regulations.

### **9.2 Disposal of the packaging**

- Dispose of the packaging, after having separated the individual materials.
- Comply with all local rules and regulations.

## 10 Technical data

### 10 Technical data

Manufacturer	Martin Christ Gefriertrocknungsanlagen GmbH An der Unteren Söse 50 37520 Osterode (Germany)	
Type	<b>Beta 1-8 LSCbasic</b>	<b>Beta 2-8 LSCbasic</b>
Part number	102420	102421
<b>Performance data</b>	<b>Beta 1-8 LSCbasic</b>	<b>Beta 2-8 LSCbasic</b>
<u>Ice condenser</u>		
- capacity	8 kg max	8 kg max
- performance	6 kg / 24 h max	6 kg / 24 h max
- temperature	approx. -55°C	approx. -85°C
- chamber volume	approx. 11 l	approx. 11 l
<u>Hot gas defrosting</u>		
- with non-flammable refrigerants:	approx. 5 h	approx. 5 h
- with flammable refrigerants:	approx. 10 h	--
<b>Connection requirements (without vacuum pump and accessories)</b>	<b>Beta 1-8 LSCbasic</b>	<b>Beta 2-8 LSCbasic</b>
Electrical connection:	1 x 230 V / 50 Hz (other supply data on request)	1 x 230 V / 50 Hz (other supply data on request)
Protection class:	I	I
IP protection category according to DIN 60529:	11	11
Apparent power:	0.9 kVA	1.3 kVA
Nominal current:	4.0 A	6.0 A
Mains fuse:	10 A	12 A
Pressure control valve connection:	230 V, 50/60 Hz, 20 VA max.	230 V, 50/60 Hz, 20 VA max.
Vacuum pump connection:	230 V, 50/60 Hz, 4.0 A max.	230 V, 50/60 Hz, 4.5 A max.
<b>Filling quantity</b>	<b>Beta 1-8 LSCbasic</b>	<b>Beta 2-8 LSCbasic</b>
Non-flammable refrigerants:	Filling quantity $\triangleq$ CO <sub>2</sub> equivalent	Filling quantity $\triangleq$ CO <sub>2</sub> equivalent
- Isceon 89	600 g $\triangleq$ 2.28 t	--
or	or	
- R290	--	8 g $\triangleq$ < 0.01 t
- R404A	400 g $\triangleq$ 1.51 t	230 g $\triangleq$ 0.87 t
- R508B	10 g $\triangleq$ 0.13 t	76 g $\triangleq$ 1.02 t
Flammable refrigerants:	Filling quantity $\triangleq$ CO <sub>2</sub> equivalent	
- R1270:	80 g $\triangleq$ < 0,01 t	--
- R170:	10 g $\triangleq$ < 0,01 t	--
<b>Physical data (without vacuum pump and accessories)</b>	<b>Beta 1-8 LSCbasic</b>	<b>Beta 2-8 LSCbasic</b>
<u>Dimensions</u>		
- height	415 mm	415 mm
- width	780 mm	780 mm
- depth	555 mm + 80 mm vacuum connection	555 mm + 80 mm vacuum connection
Weight	approx. 63 kg	approx. 78 kg

**10 Technical data**

Noise level according to DIN 45635	54 dB(A)	54 dB(A)
EMC according to EN 55011	Class B	Class B
Heat emission	0.6 kW min 1.1 kW max	1.1 kW min 1.6 kW max
<b>Equipment connections</b>	<b>Beta 1-8 LSCplus</b>	<b>Beta 2-8 LSCplus</b>
Aeration	Hose nozzle DN6 (outside diameter 10 mm max.)	Hose nozzle DN6 (outside diameter 10 mm max.)
Drain	Hose nozzle DN10 (outside diameter 12 mm)	Hose nozzle DN10 (outside diameter 12 mm)
Vacuum connection	Small flange connection DN25KF (ISO 28403, DIN 2861)	Small flange connection DN25KF (ISO 28403, DIN 2861)
Vacuum sensor	SUB D-9 VCP 63	SUB D-9 VCP 63
Option: data interface (LAN)	RJ 45	RJ 45
<b>Special equipment: water cooling system</b>	<b>Beta 1-8 LSCbasic</b>	<b>Beta 2-8 LSCbasic</b>
Part number	102422	102423
Cooling water consumption	max. 0.16 m <sup>3</sup> /h	max. 0.20 m <sup>3</sup> /h
Heat carried off via the cooling water	1.1 kW	1.6 kW
Cooling water feed flow connection	R3/4" with hose nozzle DN13	R3/4" with hose nozzle DN13
Cooling water return flow connection	R3/4" with hose nozzle DN13	R3/4" with hose nozzle DN13

## 10.1 Ambient conditions

- Use in closed spaces
- Altitudes up to 2,000 m
- Ambient temperature between +5°C and +25°C
- Maximum relative humidity of 80%
- Mains voltage fluctuations of up to ± 10% of the rated voltage

## 10.2 Technical documentation

The technical documentation of this freeze-dryer (e.g. circuit diagram, cooling system) and the safety data sheets of the manufacturers (e.g. for refrigerant) is not attached to this operating manual.

You can order these documents from our service department.

## 11 Appendix

# 11 Appendix

## 11.1 Brief operating instructions

Functional and operating elements:

- 1 Ice condenser chamber **Fehler! Textmarke nicht definiert.**
- 2 LSCplus user interface
- 3 Mains power switch



Fig. 57: Total view of the freeze-dryer

- 4 Vacuum sensor
- 5 Pipe connection of the vacuum pump (behind the cover plate)
- 6 Ice condenser

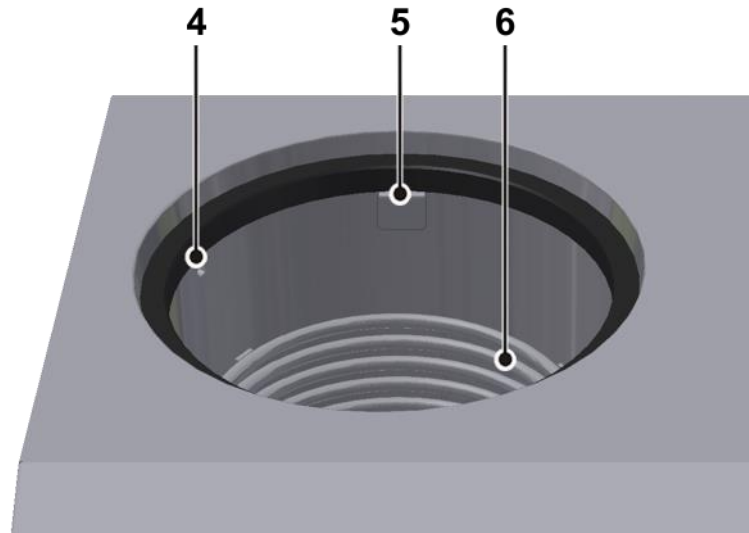

Fig. 58: Ice condenser chamber

- 7 Aeration valve
- 8 Media drain valve

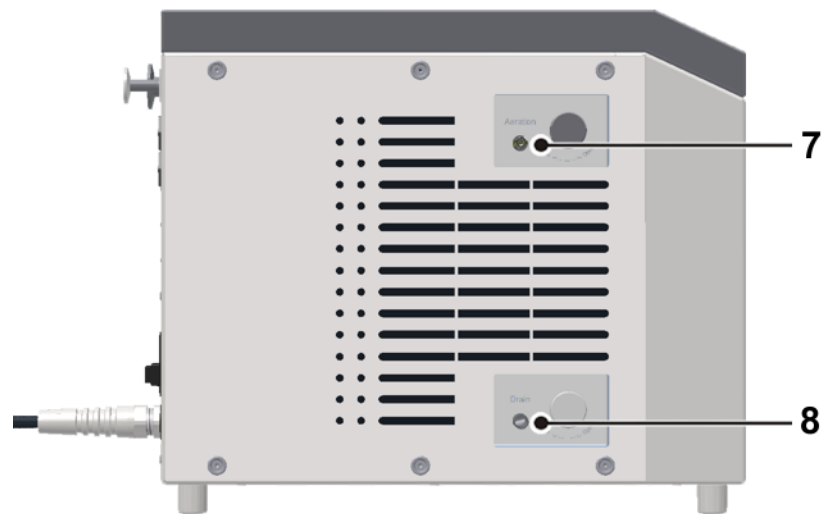

Fig. 59: Left side of the freeze-dryer

- 9 Touchpanel



Fig. 60: User interface with touchpanel

## 11 Appendix

- 10 Heat exchanger of the refrigeration unit
- 11 Name
- 12 Vacuum connection
- 13 Serial interface
- 14 Electrical connection of the vacuum sensor
- 15 Connection of the vacuum sensor
- 16 Power supply of the pressure control valve
- 17 Power supply of the vacuum pump
- 18 Mains fuse
- 19 Mains cable
- 20 Equipotential bonding screw

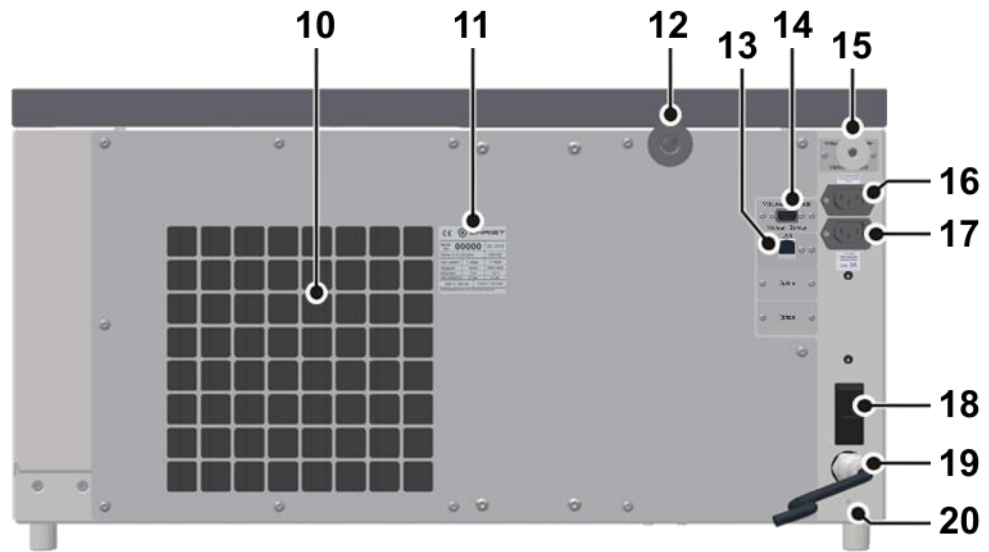

Fig. 61: Rear view of the freeze-dryer

- 1 Status line
- 2 Schematic system diagram
- 3 Values window
- 4 Button "Tools"
- 5 Button "Set"
- 6 Button "Process and equipment messages"
- 7 Button "Operating mode: select/start"
- 8 Button "Stop"

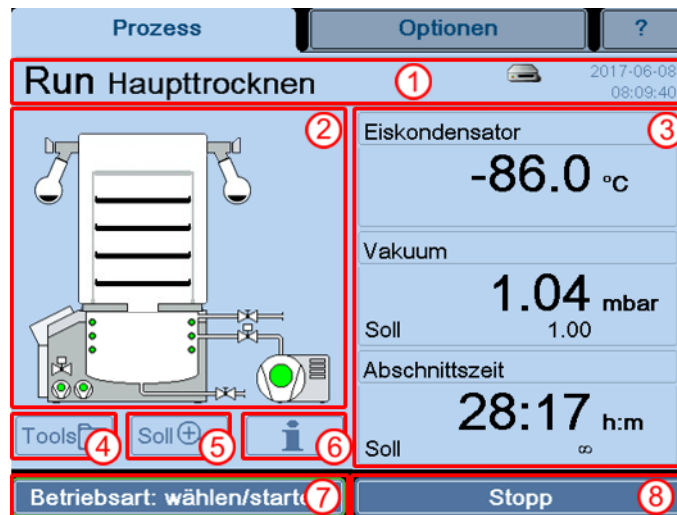

Fig. 62: LSCbasic user interface

### Step-by-step instructions – shelf drying

- 1 Freeze the sample separately, e.g. in a deep-freeze.



Ensure that the layer thickness of 1 to 2 cm is not exceeded, since otherwise the drying time needs to be extended.

- 2 Check the ice condenser chamber and ensure that it is completely free from water residues.
- 3 Close the condensate drain valve and install the base plate.



- 4 Switch the unit on 20 to 30 minutes prior to the start of the drying process in order to let the vacuum pump warm up.
- 5 Place the plate rack on the base plate.
- 6 Transport the frozen samples as quickly as possible from the deep-freeze to the freeze-dryer and place them on the shelves.



Recommendation: Store the product vessels on the aluminium shelves or, if possible, the entire rack with the shelves in the deep-freeze. The advantage is that due to the higher cold storage capacity of the aluminium material, the product will remain frozen for a longer period of time so that the sample will not thaw.

- 7 Install the drying chamber. Prior to doing so, check whether the O-ring is completely free of dirt particles. The ground-in stopper of the acrylic glass bell must be greased with high-vacuum grease.
- 8 Ensure that all of the valves of the acrylic glass bell are closed.
- 9 Ensure that the aeration valve is closed.
- 10 Ensure that the condensate drain valve is closed.
- 11 Start the main drying process either by opening the manual shut-off valve or by waiting for the electromagnetic valve to open. Vacuum is applied to the chamber and the freeze-drying process commences.



The vacuum pump always runs with maximum power. With this type of freeze-dryer, the power of the vacuum pump cannot be controlled.

- 12 The operating panel displays the vacuum, the ice condenser temperature, and the current operating mode.
- 13 The end of the process is reached when the ice condenser is no longer loaded and when it again reaches a final temperature of approximately -50°C to -54°C. The pressure decreases as a function of the ice condenser temperature.
- 14 Switch the vacuum pump off and aerate the drying chamber via the condensate drain valve or via a rubber valve.
- 15 Switch the unit off by actuating the mains power switch and take the product out of the freeze-dryer.
- 16 Switch the unit on again and start the defrosting process (button "Operating mode: select/start" – "Defrosting").



Ensure that no water gets into the pipe connection of the vacuum pump or vacuum sensor.

- 17 Drain the defrosting water via the condensate drain valve on the left-hand side of the unit. To do so, connect a hose to the hose connector and collect the defrosting water in a suitable vessel.
- 18 Keep the freeze-dryer open (i.e. without the lid or drying chamber) when it is not in use so that moisture can evaporate. This increases the service life of the vacuum sensor.

## 11 Appendix

### Step-by-step instructions – drying in a flask

- 1 Freeze the sample separately, e.g. in a deep-freeze.



Ensure that the layer thickness of 1 to 2 cm is not exceeded, since otherwise the drying time needs to be extended.

- 2 Check the ice condenser chamber and ensure that is completely free from water residues.
- 3 Install the drying chamber. Prior to doing so, check whether the O-ring is completely free of dirt particles. The ground-in stopper of the acrylic glass bell must be greased with high-vacuum grease.
- 4 Ensure that all of the valves are closed.
- 5 Let the vacuum pump warm up 20 to 30 minutes before the freeze-drying processes commences.
- 6 Connect a frozen sample to a valve.



After the pressure has fallen below 1.030 mbar, a frozen sample can be connected to a valve. The next frozen sample cannot be connected to another valve until the pressure is again lower than 1.030 bar.



After the pressure has fallen below 1.030 mbar, a frozen sample can be connected to a valve. The next frozen sample cannot be connected to another valve until the pressure is again lower than 1.030 bar.

- 7 The operating panel displays the vacuum, the ice condenser temperature, and the current operating mode.
- 8 The end of the process is reached when the ice condenser is no longer loaded and when it again reaches a final temperature of approximately -50°C to -54°C. The pressure decreases as a function of the ice condenser temperature.



The drying time depends on the layer thickness of the sample, the solids content of the sample, and the amount of heat that is supplied during the drying process. In the case of a layer thickness of 1 cm, the freeze-drying process usually takes 24 hours.

- 9 Switch the vacuum pump off and aerate the drying chamber via the condensate drain valve or via a rubber valve.
- 10 Switch the unit off by actuating the mains power switch and take the product out of the freeze-dryer.
- 11 Switch the unit on again and start the defrosting process (button "Operating mode: select/start" – "Defrosting").

**CAUTION**

Ensure that no water gets into the pipe connection of the vacuum pump or vacuum sensor.

- 12 Drain the defrosting water via the defrosting water valve on the left-hand side of the unit. To do so, connect a hose to the hose connector and collect the defrosting water in a suitable vessel.
- 13 Keep the freeze-dryer open (i.e. without the lid or drying chamber) when it is not in use so that moisture can evaporate. This increases the service life of the vacuum sensor.

## 11 Appendix

---

## 11.2 EC declaration of conformity in accordance with the EC Machinery Directive



### EC – DECLARATION OF CONFORMITY

in accordance with the EC Machinery Directive 2006/42/EC, annex II, part 1, section A

The product named hereinafter was developed, designed, and manufactured in compliance with the relevant, fundamental safety and health requirements of the listed EC directives.

In the event of modifications that were not authorised by us or if the product is used in a manner that is not in line with the intended purpose, this declaration will be rendered void.

<i>Product name:</i>	Freeze-dryer
<i>Product type:</i>	Beta 1-8 LSCbasic Beta 2-8 LSCbasic
<i>Order number:</i>	102420, 102422, 102424, 102426, 102428, 102430 102421, 102423, 102425, 102427, 102429, 102431
<i>Directives:</i>	2006/42/EG Machinery Directive 2014/35/EU Low Voltage Directive 2014/30/EU EMC Directive

**Martin Christ Gefriertrocknungsanlagen GmbH**

An der Unteren Söse 50  
37520 Osterode  
Germany

Authorised representative  
for CE matters:  
S. Krippendorff

Osterode, 07/03/2018

  
M. Christ, Management

## 11 Appendix

---

## 11.3 Declaration of conformity – China RoHS 2



### DECLARATION OF CONFORMITY

#### China RoHS 2 (Administrative Measures for the Restriction of the Use of Hazardous Substances in Electrical and Electronic Products)

Freeze-dryer models: Alpha 1-2 LDplus, Alpha 1-4 LDplus, Alpha 2-4 LDplus, Alpha 1-4 LSCbasic, Alpha 2-4 LSCbasic, Alpha 3-4 LSCbasic, Alpha 1-4 LSCplus, Alpha 2-4 LSCplus, Beta 1-8 LDplus, Beta 2-8 LDplus, Beta 1-8 LSCbasic, Beta 2-8 LSCbasic, Beta 1-8 LSCplus, Beta 2-8 LSCplus, Gamma 1-16 LSCplus, Gamma 2-16LSCplus, Delta 1-24 LSCplus, Delta 2-24 LSCplus

Rotational Vacuum Concentrator models: RVC 2-18 CDplus, RVC 2-18 CDplus HCl-resistant, RVC 2-25 CDplus, RVC 2-33 CDplus, RVC 2-33 CDplus with infrared heating

Christ Gefriertrocknungsanlagen GmbH has made reasonable effort to avoid the use of hazardous substances in the products (freeze-dryers and RVC).

A Product Conformity Assessment (PCA) was performed in order to determine whether the concentration of harmful substances in all homogeneous materials of the component parts is above or below the MCV limit (Maximum Concentration Value limit) as defined in GB/T 26572:

Mercury and its compounds: 0.1 %      Cadmium (Cd) and its compounds: 0.01 %  
Lead (Pb) and its compounds: 0.1 %      Hexavalent chromium (Cr (VI)) and its compounds: 0.1 %  
Polybrominated biphenyls (PBB): 0.1 %      Polybrominated diphenyl ethers (PBDE): 0.1 %

表1 产品中有害物质的名称及含量  
Table 1: Name and content of hazardous substances in the product

部件名称 Component part (PCA)	有害物质 Hazardous substance					
	铅 Lead (Pb)	汞 Mercury (Hg)	镉 Cadmium (Cd)	六价铬 Hexavalent Chromium (Cr (VI))	多溴联苯 Poly-brominated biphenyls (PBB)	多溴二苯醚 Polybrominated diphenyl ethers (PBDE)
Electronic PCB, cables	X <sup>1)</sup>	○	○	○	○	○
Display	○	○	○	○	○	○
Housing	X <sup>2)</sup>	○	○	○	○	○
Base, metal, accessories	X <sup>2)</sup>	○	○	○	○	○

本表格依据SJ/T 11364的规定编制。  
This table is made according to SJ/T 11364.

## 11 Appendix



O: 表示该有害物质在该部件所有均质材料中的含量均在GB/T 26572规定的限量要求以下。  
Indicates that the content of the harmful substance in all homogeneous materials of the component part is below the limit as defined in GB/T 26572.)

X: 表示该有害物质至少在该部件的某一均质材料中的含量超出GB/T 26572规定的限量要求。(企业可在此处, 根据实际情况对上表打“X”的技术原因进行进一步说明。)  
Indicates that the content of the harmful substance in at least one homogeneous material of the component part exceeds the limit as defined in GB/T 26752. (Contact the manufacturer for further technical information according to the actual situation.)

1) Contains parts in compliance with exemptions 6c, 7c.I, 7c.II and 37 of 2011/65/EU RoHS.

2) Contains parts in compliance with exemptions 6a, 6b and 6c of 2011/65/EU RoHS.

Apart from the exemptions given in this table, none of the substances listed above have been intentionally added to the product or metallic coatings.

### Martin Christ Gefriertrocknungsanlagen GmbH

An der Unteren Söse 50  
37520 Osterode  
Germany

Osterode, 14/11/2018



General Manager



## 11.4 EC declaration of conformity in accordance with the Pressure Equipment Directive



### EC – DECLARATION OF CONFORMITY

in accordance with the EC Pressure Equipment Directive 2014/68/EU

The refrigeration units in freeze-dryers which are listed hereinafter were developed, designed, and manufactured in accordance with the relevant, fundamental safety and health requirements of the listed EC directives and standards.

In the event of modifications that were not authorised by us or if the product is used in a manner that is not in line with the intended purpose, this declaration will be rendered void.

<i>Product name:</i>	Refrigeration unit in a freeze-dryer
<i>Relevant unit types:</i>	All laboratory systems of the following types: Alpha, Beta, Gamma, Delta Pilot systems of the following types: Epsilon 1-4, Epsilon 2-4 Epsilon 2-6D, Epsilon 2-10D
<i>Max. permissible pressure:</i> <i>Max. permissible temperature:</i>	25 bar 120°C
<i>Directives:</i>	2014/68/EU Pressure Equipment Directive
<i>Underlying standards:</i>	AD 2000 EN 378
<i>Applied conformity assessment procedures:</i>	Module A Category I

**Martin Christ Gefriertrocknungsanlagen GmbH**

An der Unteren Söse 50  
37520 Osterode  
Germany

Authorised representative  
for CE matters:  
S. Krippendorff

Osterode, 23/08/2016



F. Harms, Management

## 11 Appendix

---

## 11.5 Table of the sublimation pressure curve

°C	= mbar	°C	= mbar	°C	= mbar	°C	= mbar
28	37.79	1	6.57	-26	0.57	-53	0.025
27	35.64	0	6.11	-27	0.52	-54	0.024
26	33.60	-1	5.62	-28	0.47	-55	0.021
25	31.66	-2	5.17	-29	0.42	-56	0.018
24	29.83	-3	4.76	-30	0.37	-57	0.016
23	28.08	-4	4.37	-31	0.34	-58	0.014
22	26.43	-5	4.02	-32	0.31	-59	0.012
21	24.86	-6	3.69	-33	0.28	-60	0.011
20	23.37	-7	3.39	-34	0.25	-61	0.009
19	21.96	-8	3.01	-35	0.22	-62	0.008
18	20.63	-9	2.84	-36	0.20	-63	0.007
17	19.37	-10	2.56	-37	0.18	-64	0.006
16	18.17	-11	2.38	-38	0.16	-65	0.0054
15	17.05	-12	2.17	-39	0.14	-66	0.0047
14	15.98	-13	1.98	-40	0.12	-67	0.0041
13	14.97	-14	1.81	-41	0.11	-68	0.0035
12	14.02	-15	1.65	-42	0.10	-69	0.0030
11	13.12	-16	1.51	-43	0.09	-70	0.0026
10	12.27	-17	1.37	-44	0.08	-71	0.0023
9	11.47	-18	1.25	-45	0.07	-72	0.0019
8	10.72	-19	1.14	-46	0.06	-73	0.0017
7	10.01	-20	1.03	-47	0.055	-74	0.0014
6	9.35	-21	0.94	-48	0.050	-75	0.0012
5	8.72	-22	0.85	-49	0.045	-76	0.0010
4	8.13	-23	0.77	-50	0.040	-77	
3	7.58	-24	0.70	-51	0.035	-78	
2	7.06	-25	0.63	-52	0.030	-79	

## 11 Appendix

---

## 12 Glossary

### **Cold trap operation**

*Cold traps* are used for the condensation of moisture or solvents in combination with vacuum pumps. CHRIST freeze-dryers can be used as cold traps.

### **Desorption**

Desorption (from Latin de-sorbere, sorbere = sup up, suck in) describes a phenomenon whereby molecules are released from the surface of a solid. In order to be able to desorb, the particle must have, or be provided with, a sufficient amount of energy in order to overcome the binding energy.

### **Double-chamber method**

Drying on shelves outside the ice condenser chamber is referred to as a double-chamber system. The advantage compared to the → *single-chamber method* is the considerably higher product capacity. In addition, the product chamber can be isolated from the ice condenser chamber by an intermediate valve in order to perform a → *pressure increase test* for determining the end of the drying process. In freeze-dryers without active shelf cooling, the samples need to be prefrozen externally, e.g. in a deep-freeze or freezer cabinet. After the transfer of the product into the freeze-dryer, the actual → *sublimation* is started.

### **Eutectic point**

The eutectic point is the point at which a homogeneous mixture (e.g. a eutectic alloy) passes directly from the liquid to the solid phase without the formation of a crystal mixture that consists of different phases.

### **Reference designation**

Within the life cycle of industrial systems, a uniform equipment identification system is required for planning, design, implementation, operation, maintenance and dismantling so that all of the objects within the system can be clearly identified at any time. The reference designations (also known as device tags) are affixed to the equipment or components and entered into the technical documents (e.g. circuit diagram).

### **Safety pressure**

Since the vacuum has a dominating influence on the product temperature, Martin Christ Gefriertrocknungsanlagen GmbH has integrated a safety pressure feature into the freeze-dryers in order to ensure the protection of the product. If the pressure inside the drying chamber increases too strongly so that it exceeds the safety limit, the energy supply of the shelves will be interrupted and the sublimation process slows down. This prevents the product from melting.

The safety pressure value that is entered should correspond to a temperature value that is 5°C below the melting point of the product on the vapour pressure curve for ice and water.

### **Single-chamber method**

(not available for freeze-dryers with an LSCbasic control system)

## 12 Glossary

---

With the single-chamber method, the freezing as well as the subsequent drying of the product take place inside the ice condenser chamber. The sample is frozen as a result of the low temperature of the ice condenser (-55°C in the case of single-stage systems or -85°C in the case of double-stage systems). During this process, the inside of the chamber can be cooled down to approx. -20°C or -40°C. The moderate supply of the frozen sample with energy, which is necessary during the main drying phase, is ensured by heatable shelves on which the product is placed.

### **Sublimation**

Sublimation (from Latin "sublimis" = high up in the air, raised) is a thermodynamic process of the direct transition of a substance from the solid phase to the gas phase.

## 13 Index

### A

Access protection.....	58
Accessories .....	12, 31, 74, 80
Accident prevention .....	24
Accident prevention regulations .....	23
Acids.....	11, 30
Acids (hazards).....	28
Administration .....	55
Aeration .....	36, 65
Aeration (connection .....	85
Aeration valve .....	14, 37
Aeration valve (cleaning and care).....	76
Aeration valve, malfunction .....	71
Ambient conditions.....	85
Ambient temperature .....	36, 85
Apparent power .....	15, 84

### B

Beeper .....	57
Behaviour of the pressure control valve in the case of insufficient ice condenser cooling .....	57
Brief operating instructions.....	86
Button "Standard unit test" .....	51
Button "Stop" .....	52

### C

CE mark in compliance with the directive 2006/42/EC .....	21
Changing of operating supplies.....	30
Chemical reactions .....	80
China RoHS 2 – Declaration of conformity.	95
Circuit diagram.....	85
Cleaning .....	30
Cleaning agents.....	74, 80
Cleaning of the freeze-dryer.....	75
Cleaning the accessories .....	74
Cleaning the freeze-dryer.....	74
Click on touch .....	57
Cold trap operation .....	54
Commissioning .....	12
Compatibility test.....	23

Compliance with the EC health and safety directives .....	23
Condensate, contaminated (hazards) .....	29, 38, 71, 76
Connection.....	31
Connection (hazards).....	26
Connection of the vacuum sensor.....	15
Connection requirements .....	84
Contaminated condensate (hazards) .....	29, 38, 71, 76
Contaminated defrosting water (hazards) .....	29, 38, 71, 76
Control system type .....	64
Cooling system .....	85
Copyright .....	12
Corrosion .....	74, 80
Cost estimate.....	82
Cracks .....	80
Customer-provided fuses .....	37

### D

Damage to the materials of construction ...	74
Dangerous materials.....	80
Data interface (LAN) .....	85
Date/Time .....	55
Declaration of conformity – China RoHS 2.	95
Declaration of conformity (Machinery Directive).....	12, 93
Declaration of conformity (Pressure Equipment Directive) .....	97
Declaration of decontamination.....	82
Decontamination agents .....	80
Defrosting .....	20, 65
Defrosting water, contaminated (hazards).....	29, 38, 71, 76
Defrosting with hot gas.....	20
Desorption .....	101
Details.....	49
Details concerning the software version.....	64
Device options .....	59
Device tag.....	101
Dialogue box "Operating mode: select/start" .....	50

## Index

Dialogue box "Process and equipment messages".....	48	Freeze-dryer type.....	64
Dialogue box "Schematic system diagram" 46		Freeze-dryer, cleaning and care .....	75
Dialogue box "Tools".....	47	Freeze-drying of acid-containing products..	11
Dimensions .....	33, 84	Freeze-drying of solvent-containing products .....	9, 23
Direct hazard to the life and health.....	22	Freeze-drying phases .....	18
Disinfectants .....	80	Freeze-drying process .....	18, 54
Disinfection of the drying chamber and accessories .....	80	Freeze-drying process, start .....	64
Displayed vacuum value is not correct .....	69	Freezing.....	19
Disposal of the freeze-dryer .....	83	Functional and operating elements .....	13
Disposal of the packaging .....	83	<b>G</b>	
Double-chamber method.....	54, 101	General conditions .....	11
Double-chamber method LyoCube (outside) .....	54	General information on freeze-drying .....	16
Drain (connection).....	85	General malfunctions .....	68
<b>E</b>		General work (maintenance).....	74
Earth conductor check .....	29	<b>H</b>	
EC declaration of conformity (Machinery Directive) .....	12, 93	Handling hazardous materials.....	32
EC declaration of conformity (Pressure Equipment Directive) .....	97	Hazard warnings.....	9, 11
Electrical connection .....	84	Hazardous materials, handling.....	32
Electrical connection of the vacuum sensor	15	Hazards (acids).....	28
Electrical system (maintenance) .....	77	Hazards (connection) .....	26
Electricity (hazards) .....	26, 37, 77	Hazards (contaminated condensate).....	29, 38, 71, 76
EMC according to EN 55011 .....	85	Hazards (contaminated defrosting water).....	29, 38, 71, 76
End of drying and aeration .....	20	Hazards (electricity) .....	26, 37, 77
Entering set values .....	65	Hazards (general, transport to commissioning) .....	25
Environmental protection .....	24	Hazards (products, harmful).....	28
Equipment connections.....	85	Hazards (refrigeration system) .....	27
Equipotential bonding screw .....	15, 29, 37	Hazards (set-up) .....	25
Error correction .....	68	Hazards (solvents) .....	28
Error messages .....	29	Hazards (surfaces, cold) .....	29
Eutectic point .....	101	Hazards (surfaces, hot).....	29
Exhaust filter .....	40, 78	Hazards (transport) .....	25
Explanation of symbols .....	12	Health, safety and accident prevention regulations.....	23
Explanation of the symbols and notes.....	22	Heat emission .....	85
External data storage device.....	45	Heat exchanger .....	77
<b>F</b>		Heat exchanger of the refrigeration unit .....	15
Failure memory .....	61	Hot-gas defrosting.....	20
Filling quantity .....	84	Humidity.....	85
Final drying .....	20	<b>I</b>	
Fire prevention.....	31	Ice condenser .....	84
Form for the return of defective parts .....	82	Ice condenser chamber.....	13



Ice condenser chamber, cleaning and care	75	Max. humidity.....	85
Importance of the operating manual.....	9	Maximum current for the vacuum pump .....	40
Important information .....	22	Measures to be taken to ensure safe operation .....	31
Infectious substances .....	80	Media drain .....	65
Informal safety notes.....	24	Media drain valve.....	14, 38
Initial start-up .....	43	Media drain valve (cleaning and care).....	76
Inspection by the manufacturer .....	81	Media drain valve, malfunction.....	71
Installation of accessories .....	43	Mode of operation.....	16
Insufficient ice condenser or shelf temperature.....	69	<b>N</b>	
Insufficient ice condenser temperature.....	72	Name plate .....	15
Insufficient vacuum .....	68, 70	Network .....	56
Intended use.....	9	Network drive.....	45
IP protection category according to DIN 60529 .....	84	No indication on the display .....	68
<b>L</b>		Noise level .....	85
Language.....	53	Nominal current .....	84
Layout of the freeze-dryer .....	13	Nominal voltage .....	15, 26
Leakage in a rubber valve.....	68	Notes on safety and hazards .....	9
Leakage in the media drain valve.....	68	Notes on transport .....	34
Leakage test .....	52, 65, 67	<b>O</b>	
Location of use .....	36	Oil mist separator.....	40, 78
LSCbasic control system.....	44	Operating elements.....	13
Lyes.....	30	Operating hours .....	60
LyoLogplus data logging software .....	67	Operating mode: select/start .....	50
<b>M</b>		Operating personnel .....	24
Main drying .....	19	Operating state .....	45
Main window "?" .....	64	Operating voltage.....	37
Main window "Options" .....	53	Operation .....	31
Main window "Process" .....	45	Operational safety.....	80
Mains cable.....	15	Operator/maintenance/administrator password.....	59
Mains fuse .....	15, 84	Option: Leakage test.....	52
Mains voltage.....	85	Option: USB process recording.....	48
Maintenance .....	30, 62	Optional extensions .....	67
Maintenance (electrical system).....	77	<b>P</b>	
Maintenance (general work).....	74	Packaging.....	35, 83
Maintenance (vacuum sensor) .....	79	Part number .....	15, 84, 85
Maintenance and service .....	74	Password input fails .....	68
Maintenance performed by the user.....	74	Password timer runtime .....	58
Malfunction of the pressure control valve ...	71	Pathogenic substances.....	75, 80
Malfunctions.....	68	Performance data .....	84
Manufacturer.....	74, 80, 83, 84	Performance test.....	51
Manufacturer contact data .....	64	Physical data .....	84
Marking of the unit .....	21	Potential hazard to the life and health .....	22
Materials of construction, damage .....	74		

## Index

Potentially hazardous situation.....	22	Safety notes concerning the operation .....	26
Power failure.....	69	Safety notes concerning the transport.....	25
Power supply .....	37	Safety pressure.....	101
Power supply of the pressure control valve	15	Safety-conscious work .....	23
Power supply of the vacuum pump .....	15	Scale unit (unit of measurement) .....	54
Preparation .....	18, 43	Schematic system diagram .....	46
Pressure control valve .....	41	Scope of supply .....	12
Pressure control valve, malfunction .....	71	Sensor adjustment.....	63
Pressure marks.....	80	Serial interface.....	15
Prevention of accidents.....	9	Serial number .....	15, 64, 73, 81
Procedures in the event of hazards and accidents.....	30	Service.....	60, 81
Process and equipment messages .....	48	Service contact .....	73
Process and error messages .....	72	Service life .....	74
Process data.....	45	Service work .....	81
Products containing acids .....	11	Set process values.....	48
Products, harmful (hazards).....	28	Set-up.....	31
Protection class .....	37, 84	Set-up (hazards) .....	25
<b>R</b>		Set-up and connection .....	36
Radioactive substances .....	75	Signs of corrosion .....	80
Rated current .....	15	Single-chamber method.....	101
Reference designation .....	49, 60, 101	Small flange connections .....	70
Refrigerant.....	84	Solvent-containing products.....	9
Refrigerant data .....	15	Solvents.....	30
Refrigeration problems		Solvents (hazards) .....	28
Conditions at the location of use .....	36	Solvents.....	74
Refrigeration system (hazards) .....	27	Special equipment:water cooling system ...	85
Regulations concerning health, safety and accident prevention .....	23	Specialist personnel.....	71, 76, 81, 82
Remaining hazards.....	32	Standard unit test.....	51
Responsibility of the operator.....	23	Standards and regulations .....	12
Return of defective parts .....	81	Starting a freeze-drying process .....	64
Risk assessment.....	23	Status line .....	45
Rubber valves.....	42, 71	Step-by-step instructions – drying in a flask	90
<b>S</b>		Step-by-step instructions – shelf drying.....	88
Safe operation .....	31	Storage .....	33
Safety and hazard notes .....	24	Storage and transport .....	33
Safety area .....	31	Storage conditions .....	33
Safety data sheets .....	85	Stress-corrosion.....	80
Safety devices .....	29	Sublimation .....	102
Safety distance .....	26, 36	Supply voltage .....	37
Safety instructions.....	9, 11	Surfaces, cold (hazards) .....	29
Safety notes concerning set-up and connection.....	25	Surfaces, hot (hazards).....	29
Safety notes concerning the initial start-up.	25	Switching the freeze-dryer OFF .....	67
		Switching the freeze-dryer on.....	43
		System check .....	29
		System properties.....	57

**T**

Table of the sublimation pressure curve.....	99
Technical data .....	84
Technical documentation .....	85
Thermal stress .....	36, 74
Tools.....	47
Topping-up of operating supplies .....	30
Touchpanel.....	14
Touchpanel does not react.....	68
Toxic substances .....	75
Transport .....	33
Transport (hazards) .....	25
Transport to commissioning (hazards, general).....	25
Type.....	15, 84
Type of connection.....	37

**U**

Units of protection class I .....	37
USB process recorder.....	67
USB process recording .....	48
User interface .....	44
UV radiation .....	36, 74

**V**

Vacuum connection .....	15, 85
Vacuum pump.....	40
Vacuum pump connection.....	84
Vacuum pump is not activated .....	69
Vacuum pump oil change.....	61
Vacuum pump, cleaning and care.....	78
Vacuum sensor.....	38, 71, 85
Vacuum sensor (maintenance) .....	79
Value windows.....	46
Vapour pressure curve for ice and water..... .....	17, 47
Ventilation.....	72
Vents .....	36
Viewing or editing the set values.....	66

**W**

Warranty and liability.....	11
Water cooling system.....	85
Weight .....	33, 84

**Y**

Year of manufacture .....	15
---------------------------	----